



XRADICAL

SUPER GASKETS

EDITION 11

ARCTIC CAT

BETA

CCM

FANTIC

GAS GAS

HONDA

HUSABERG

HUSQVARNA

KAWASAKI

KTM

RIEJU

SUZUKI

YAMAHA

POWERED BY:

AFARTEIN
gaskets

GASKETS • JOINTS • JUNTAS • GUARNIZIONI • DICHTUNGEN



ARTEIN GASKETS – ARTESANÍA INDUSTRIAL, S.L.
 Passeig Pep Ventura, 74-76 - Pol. Ind. Fornells de La Selva
 E17458 - Fornells de La Selva – GIRONA - Spain
 Tel. +34 972 201 272 - info@arteingaskets.com
 www.arteingaskets.com

SCAN TO ACCESS THE
 LATEST UPDATE



INDEX

INTRODUCTION	4 - 5
LIST BY BRAND	6 - 23
BETA	BT/1 - BT/4
GAS GAS / RIEJU	GG/1 - GG/10
HONDA	HN/1 - HN/40
HUSQVARNA	HU/1 - HU/2
KAWASAKI / SUZUKI	KW/1 - KW/22
KTM / HUSQVARNA / HUSABERG / GAS GAS	KT/1 - KT/32
SUZUKI	SZ/1 - SZ/4
YAMAHA / GAS GAS / CCM/ FANTIC	YM/1 - YM/28
QUAD	
GAS GAS	GG/1 - GG/4
HONDA	HN/1 - HN/4
KTM	KT/1 - KT/2
SUZUKI / KAWASAKI / ARCTIC CAT	SZ/1 - SZ/2
YAMAHA	YM/1 - YM/8
TEFIBRAL	190 - 191

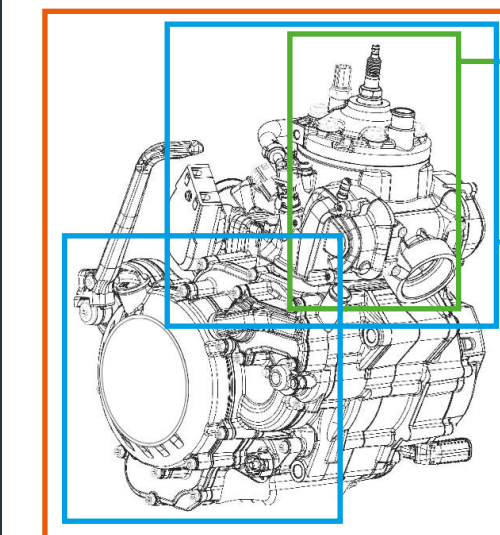

- TOP END KIT K**
 Essential Gasket Kit for cylinder set up.
 Gaskets included: Cylinder Base, Cylinder Head, Valve Stem Seals, Exhaust, Exhaust Valve, Reed Valve and Distribution Chain Tensioner.
- SMART KIT S**
 Extended Gasket Kit,
 Gaskets included: Top End Kit + Clutch Cover, Friction Disc Cover, Water Pump Cover.
- COMPLETE SET J**
 Indispensable Gasket Set for a complete engine maintenance.

KEY

	ARTEIN PART No
	ORIGINAL PART No
	GASKET INCLUDED IN TOP END KIT
	GASKET INCLUDED IN SMART KIT
	GASKET INCLUDED IN COMPLETE SET
	DESCRIPTION

T560005200200 | 0770052020
 CYLINDER HEAD GASKET (INNER)

THE BEST ALLY FOR COMPETITION



ARTEIN
gaskets

ARTEIN GASKETS manufactures gaskets and other components related to the automotive industry, such as rubber parts, technical foams and heat shields.

We are a reliable partner for OEM Customers and we are successfully involved in the MotorSport World.

The performance of ARTEIN XRADICAL SUPER GASKETS equals and usually exceeds the specifications of the original ones. We manufacture with state-of-the-art technology and top grade materials.

Our commitment is to provide our clients with absolute compatibility, the highest quality, extensive information and the best customer service.

XRADICAL

SUPER GASKETS



ARCTIC CAT

C.C.	MODEL	SINCE	UNTIL	STROKE	TOP END KIT	SMART KIT	COMPLETE SET	PAGES
400	DVX 400	2004	2008	4T	K0000SZ0K0471	S0000SZ0S0471	J0000SZ000471	SZ 1-2

XRADICAL
SUPER GASKETS

BETA

C.C.	MODEL	SINCE	UNTIL	STROKE	TOP END KIT	SMART KIT	COMPLETE SET	PAGES
125	RR 125	2018	>>	2T	K0000BT0K0872	S0000BT0S0872	J0000BT000872	BT 1-2
125	RR 125 RACING	2019	>>	2T	K0000BT0K0872	S0000BT0S0872	J0000BT000872	BT 1-2
200	RR 200	2019	>>	2T	K0000BT0K0872	S0000BT0S0872	J0000BT000872	BT 1-2
200	RR 200 RACING	2021	>>	2T	K0000BT0K0872	S0000BT0S0872	J0000BT000872	BT 1-2
250	RR 250	2013	>>	2T	K0000BT0K0866	S0000BT0S0866	J0000BT000866	BT 3-4
250	RR 250 RACING	2013	>>	2T	K0000BT0K0866	S0000BT0S0866	J0000BT000866	BT 3-4
300	RR 300	2013	>>	2T	K0000BT0K0866	S0000BT0S0866	J0000BT000866	BT 3-4
300	RR 300 RACING	2013	>>	2T	K0000BT0K0866	S0000BT0S0866	J0000BT000866	BT 3-4

XRADICAL
SUPER GASKETS

CCM

C.C.	MODEL	SINCE	UNTIL	STROKE	TOP END KIT	SMART KIT	COMPLETE SET	PAGES
450	MX 450	2008	2008	4T	K0000YM0K0812	S0000YM0S0812	J0000YM000812	YM 21-22

XRADICAL
SUPER GASKETS

FANTIC

C.C.	MODEL	SINCE	UNTIL	STROKE	TOP END KIT	SMART KIT	COMPLETE SET	PAGES
125	XX 125	2021	>>	2T	K0000YM0K0849	S0000YM0S0849	J0000YM000849	YM 7-8
125	XE 125	2021	>>	2T	K0000YM0K0849	S0000YM0S0849	J0000YM000849	YM 7-8
125	XX 125	2022	>>	2T	K0000YM0K0882	S0000YM0S0882	J0000YM000882	YM 9-10
250	XX 250	2022	>>	2T	K0000YM0K0851	S0000YM0S0851	J0000YM000851	YM 11-12

XRADICAL
SUPER GASKETS

GAS GAS

C.C.	MODEL	SINCE	UNTIL	STROKE	TOP END KIT	SMART KIT	COMPLETE SET	PAGES
50	MC 50	2021	>>	2T	K0000KT0K0801	S0000KT0S0801	J0000KT000801	KT 1-2
65	MC 65	2021	>>	2T	K0000KT0K0802	S0000KT0S0802	J0000KT000802	KT 3-4
85	MC 85	2021	>>	2T	K0000KT0K0804	S0000KT0S0804	J0000KT000804	KT 7-8
125	EC 125	2001	2013	2T	K0000GG0K0859	S0000GG0S0859	J0000GG000859	GG 1-2
125	MC 125	2021	>>	2T	K0000KT0K0869	S0000KT0S0869	J0000KT000869	KT 13-14
200	EC 200	1998	2004	2T	K0000GG0K0860	S0000GG0S0860	J0000GG000860	GG 3-4
200	EC 200	2005	2013	2T	K0000GG0K0861	S0000GG0S0861	J0000GG000861	GG 5-6
200	EC 200	2014	2017	2T	K0000GG0K0862	S0000GG0S0862	J0000GG000862	GG 7-8
200	EC 200	2018	2019	2T	K0000GG0K0863	S0000GG0S0863	J0000GG000863	GG 9-10
250	EC 250	1998	2004	2T	K0000GG0K0860	S0000GG0S0860	J0000GG000860	GG 3-4
250	EC 250	2005	2013	2T	K0000GG0K0861	S0000GG0S0861	J0000GG000861	GG 5-6
250	EC 250	2014	2017	2T	K0000GG0K0862	S0000GG0S0862	J0000GG000862	GG 7-8
250	EC 250	2018	2019	2T	K0000GG0K0863	S0000GG0S0863	J0000GG000863	GG 9-10
250	EC 250	2021	>>	2T	K0000KT0K0867	S0000KT0S0880	J0000KT000880	KT 23-24
250	EC 250 F	2013	2015	4T	K0000YM0K0810	S0000YM0S0810	J0000YM0J0810	YM 13-14
250	MC 250	2022	>>	2T	K0000KT0K0867	S0000KT0S0880	J0000KT000880	KT 23-24
250	EX 250	2022	>>	2T	K0000KT0K0867	S0000KT0S0880	J0000KT000880	KT 23-24
300	EC 300	1998	2004	2T	K0000GG0K0860	S0000GG0S0860	J0000GG000860	GG 3-4
300	EC 300	2005	2013	2T	K0000GG0K0861	S0000GG0S0861	J0000GG000861	GG 5-6
300	EC 300	2014	2017	2T	K0000GG0K0862	S0000GG0S0862	J0000GG000862	GG 7-8
300	EC 300	2018	2019	2T	K0000GG0K0863	S0000GG0S0863	J0000GG000863	GG 9-10
300	EC 300	2021	>>	2T	K0000KT0K0867	S0000KT0S0880	J0000KT000880	KT 23-24
300	EX 300	2021	>>	2T	K0000KT0K0867	S0000KT0S0880	J0000KT000880	KT 23-24
450	EC 450 F	2013	2015	4T	K0000YM0K0812	S0000YM0S0812	J0000YM000812	YM 21-22
300	WILD HP 300	2002	2004	4T	K0000GG0K0860	S0000GG0S0860	J0000GG000860	GG 1-2
300	WILD HP 300	2005	2006	4T	K0000GG0K0861	S0000GG0S0861	J0000GG000861	GG 3-4

HONDA

C.C.	MODEL	SINCE	UNTIL	STROKE	TOP END KIT	SMART KIT	COMPLETE SET	PAGES
125	CR 125 R	1990	1997	2T	K0000HN0K0871	S0000HN0S0871	J0000HN000871	HN 1-2
125	CR 125 R	2000	2002	2T	K0000HN0K0852	S0000HN0S0852	J0000HN000852	HN 3-4
125	CR 125 R	2003	2003	2T	K0000HN0K0853	S0000HN0S0853	J0000HN000853	HN 5-6
125	CR 125 R	2004	2004	2T	K0000HN0K0854	S0000HN0S0854	J0000HN000854	HN 7-8
125	CR 125 R	2005	2007	2T	K0000HN0K0855	S0000HN0S0855	J0000HN000855	HN 9-10
250	CR 250 R	1992	2001	2T	K0000HN0K0856	S0000HN0S0856	J0000HN000856	HN 11-12
250	CR 250 R	2002	2003	2T	K0000HN0K0857	S0000HN0S0857	J0000HN000857	HN 13-14
250	CRF 250 R	2004	2009	4T	K0000HN0K0832	S0000HN0S0832	J0000HN000832	HN 17-18
250	CRF 250 X	2004	2017	4T	K0000HN0K0832	S0000HN0S0832	J0000HN000832	HN 17-18
250	CR 250 R	2004	2007	2T	K0000HN0K0858	S0000HN0S0858	J0000HN000858	HN 15-16
250	CRF 250 R	2010	2017	4T	K0000HN0K0832	S0000HN0S0833	J0000HN000833	HN 19-20
250	CRF 250 R	2018	2021	4T	K0000HN0K0873	S0000HN0S0873	J0000HN000873	HN 21-22
250	CRF 250 RX	2019	2021	4T	K0000HN0K0873	S0000HN0S0873	J0000HN000873	HN 21-22
250	CRF 250 R	2022	>>	4T	K0000HN0K0874	S0000HN0S0874	J0000HN000874	HN 23-24
250	CRF 250 RX	2022	>>	4T	K0000HN0K0874	S0000HN0S0874	J0000HN000874	HN 23-24
450	CRF 450 R	2002	2004	4T	K0000HN0K0834	S0000HN0S0834	J0000HN000834	HN 25-26
450	CRF 450 R	2005	2006	4T	K0000HN0K0835	S0000HN0S0835	J0000HN000835	HN 27-28
450	CRF 450 X	2005	2018	4T	K0000HN0K0838	S0000HN0S0838	J0000HN000838	HN 33-34
450	CRF 450 R	2007	2008	4T	K0000HN0K0836	S0000HN0S0836	J0000HN000836	HN 29-30
450	CRF 450 R	2009	2016	4T	K0000HN0K0837	S0000HN0S0837	J0000HN000837	HN 31-32
450	CRF 450 R	2017	2018	4T	K0000HN0K0883	S0000HN0S0883	J0000HN000883	HN 35-36
450	CRF 450 RX	2017	2018	4T	K0000HN0K0883	S0000HN0S0883	J0000HN000883	HN 35-36
450	CRF 450 R	2019	2020	4T	K0000HN0K0884	S0000HN0S0884	J0000HN000884	HN 37-38
450	CRF 450 RX	2019	2020	4T	K0000HN0K0884	S0000HN0S0884	J0000HN000884	HN 37-38
450	CRF 450 R	2021	>>	4T	K0000HN0K0885	S0000HN0S0885	J0000HN000885	HN 39-40
450	CRF 450 RX	2021	>>	4T	K0000HN0K0885	S0000HN0S0885	J0000HN000885	HN 39-40

HONDA

C.C.	MODEL	SINCE	UNTIL	STROKE	TOP END KIT	SMART KIT	COMPLETE SET	PAGES
400	TRX 400 EX	2005	2012	4T	K0000HN0K0353	S0000HN0S0353	J0000HN000353	HN 1-2
450	TRX 450 R	2004	2005	4T	K0000HN0K0354	S0000HN0S0354	J0000HN000354	HN 3-4

XRADICAL
SUPER GASKETS

HUSABERG

C.C.	MODEL	SINCE	UNTIL	STROKE	TOP END KIT	SMART KIT	COMPLETE SET	PAGES
125	TE 125	2012	2014	2T	K0000KT0K0845	S0000ST0K0845	J0000KT000845	KT 11-12
250	TE 250	2011	2014	2T	K0000KT0K0805	S0000ST0K0805	J0000KT000805	KT 17-18
300	TE 300	2011	2014	2T	K0000KT0K0805	S0000ST0K0805	J0000KT000805	KT 17-18

XRADICAL
SUPER GASKETS

HUSQVARNA

C.C.	MODEL	SINCE	UNTIL	STROKE	TOP END KIT	SMART KIT	COMPLETE SET	PAGES
65	TC 65	2017	>>	2T	K0000KT0K0802	S0000KT0S0802	J0000KT000802	KT 3-4
85	TC 85	2014	2017	2T	K0000KT0K0803	S0000KT0S0803	J0000KT000803	KT 5-6
85	TC 85	2018	>>	2T	K0000KT0K0804	S0000KT0S0804	J0000KT000804	KT 7-8
125	CR 125	1997	2014	2T	K0000HU0K0868	S0000HU0S0868	J0000HU000868	HU 1-2
125	WR-E 125	1997	2014	2T	K0000HU0K0868	S0000HU0S0868	J0000HU000868	HU 1-2
125	SMS 125	1998	2014	2T	K0000HU0K0868	S0000HU0S0868	J0000HU000868	HU 1-2
125	WR 125	1998	2012	2T	K0000HU0K0868	S0000HU0S0868	J0000HU000868	HU 1-2
125	TE 125	2014	2016	2T	K0000KT0K0845	S0000KT0S0845	J0000KT000845	KT 11-12
125	TC 125	2014	2015	2T	K0000KT0K0870	S0000KT0S0870	J0000KT000870	KT 9-10
125	TC 125	2016	2022	2T	K0000KT0K0869	S0000KT0S0869	J0000KT000869	KT 13-12
125	TX 125	2017	2019	2T	K0000KT0K0869	S0000KT0S0869	J0000KT000869	KT 13-12
125	TC 125	2023	>>	2T	K0000KT0K0879	S0000KT0S0879	J0000KT000879	KT 15-16
150	TE 150	2017	2019	2T	K0000KT0K0869	S0000KT0S0869	J0000KT000869	KT 13-12
150	TE i 150	2020	2022	2T	K0000KT0K0869	S0000KT0S0869	J0000KT000869	KT 13-12
250	TC 250	2014	2016	2T	K0000KT0K0805	S0000KT0S0805	J0000KT000805	KT 17-18
250	TE 250	2014	2016	2T	K0000KT0K0805	S0000KT0S0805	J0000KT000805	KT 17-18
250	TE 250	2017	2018	2T	K0000KT0K0867	S0000KT0S0867	J0000KT000867	KT 21-22
250	TC 250	2017	2018	2T	K0000KT0K0867	S0000KT0S0867	J0000KT000867	KT 21-22
250	TE 250 i	2018	2019	2T	K0000KT0K0867	S0000KT0S0867	J0000KT000867	KT 21-22
250	TC 250	2019	2022	2T	K0000KT0K0867	S0000KT0S0880	J0000KT000880	KT 23-24
250	TE 250 i	2020	2022	2T	K0000KT0K0867	S0000KT0S0880	J0000KT000880	KT 23-24
250	TE 250	2023	>>	2T	K0000KT0K0867	S0000KT0S0880	J0000KT000880	KT 23-24
300	TE 300	2015	2016	2T	K0000KT0K0805	S0000KT0S0805	J0000KT000805	KT 17-18
300	TE 300	2017	2018	2T	K0000KT0K0867	S0000KT0S0867	J0000KT000867	KT 21-22
300	TX 300	2017	2018	2T	K0000KT0K0867	S0000KT0S0867	J0000KT000867	KT 21-22

HUSQVARNA

C.C.	MODEL	SINCE	UNTIL	STROKE	TOP END KIT	SMART KIT	COMPLETE SET	PAGES
300	TE 300 i	2018	2019	2T	K0000KT0K0867	S0000KT0S0867	J0000KT000867	KT 21-22
300	TX 300	2019	2019	2T	K0000KT0K0867	S0000KT0S0880	J0000KT000880	KT 23-24
300	TE 300 i	2020	2022	2T	K0000KT0K0867	S0000KT0S0880	J0000KT000880	KT 23-24
300	TX 300 i	2020	2022	2T	K0000KT0K0867	S0000KT0S0880	J0000KT000880	KT 23-24
300	TE 300	2023	>>	2T	K0000KT0K0867	S0000KT0S0880	J0000KT000880	KT 23-24
350	FE 350	2014	2016	4T	K0000KT0K0807	S0000KT0S0807	J0000KT000807	KT 25-26

XRADICAL
SUPER GASKETS

KAWASAKI

C.C.	MODEL	SINCE	UNTIL	STROKE	TOP END KIT	SMART KIT	COMPLETE SET	PAGES
65	KX 65	2000	>>	2T	K0000KW0K0817	S0000KW0S0817	J0000KW000817	KW 1-2
80	KX 80	1998	2000	2T	K0000KW0K0824	S0000KW0S0824	J0000KW000824	KW 3-4
85	KX 85	2001	2013	2T	K0000KW0K0824	S0000KW0S0824	J0000KW000824	KW 3-4
85	KX 85	2014	2021	2T	K0000KW0K0864	S0000KW0S0864	J0000KW000864	KW 5-6
250	KLX 250	2006	2016	4T	K0000KW0K0826	S0000KW0S0826	J0000KW000826	KW 7-8
250	KLX 250 S	2009	2014	4T	K0000KW0K0826	S0000KW0S0826	J0000KW000826	KW 7-8
250	KX 250 F	2009	2016	4T	K0000KW0K0830	S0000KW0S0830	J0000KW000830	KW 11-12
250	KX 250 F	2017	2019	4T	K0000KW0K0831	S0000KW0S0831	J0000KW000831	KW 13-14
250	KLX 250	2017	2018	4T	K0000KW0K0827	S0000KW0S0827	J0000KW000827	KW 9-10
450	KX 450 F	2006	2008	4T	K0000KW0K0828	S0000KW0S0828	J0000KW000828	KW 17-18
450	KLX 450 R	2008	2019	4T	K0000KW0K0825	S0000KW0S0825	J0000KW000825	KW 15-16
450	KX 450 F	2009	2015	4T	K0000KW0K0865	S0000KW0S0865	J0000KW000865	KW 19-20
450	KX 450 F	2016	2018	4T	K0000KW0K0829	S0000KW0S0829	J0000KW000829	KW 21-22
400	KFX 400	2003	2006	4T	K0000SZ0K0471	S0000SZ0S0471	J0000SZ000471	SZ 1-2

XRADICAL
SUPER GASKETS

KTM

C.C.	MODEL	SINCE	UNTIL	STROKE	TOP END KIT	SMART KIT	COMPLETE SET	PAGES
50	SX 50	2009	>>	2T	K0000KT0K0801	S0000KT0S0801	J0000KT000801	KT 1-2
50	SX 50 JUNIOR	2009	2009	2T	K0000KT0K0801	S0000KT0S0801	J0000KT000801	KT 1-2
50	SX 50 MINI	2009	>>	2T	K0000KT0K0801	S0000KT0S0801	J0000KT000801	KT 1-2
50	SXS 50	2011	2016	2T	K0000KT0K0801	S0000KT0S0801	J0000KT000801	KT 1-2
65	SX 65	2009	>>	2T	K0000KT0K0802	S0000KT0S0802	J0000KT000802	KT 3-4
65	XC 65	2009	2009	2T	K0000KT0K0802	S0000KT0S0802	J0000KT000802	KT 3-4
65	SXS 65	2012	2015	2T	K0000KT0K0802	S0000KT0S0802	J0000KT000802	KT 3-4
85	MX 85	2003	2009	2T	K0000KT0K0803	S0000KT0S0803	J0000KT000803	KT 5-6
85	SX 85	2004	2017	2T	K0000KT0K0803	S0000KT0S0803	J0000KT000803	KT 5-6
85	XC 85	2008	2009	2T	K0000KT0K0803	S0000KT0S0803	J0000KT000803	KT 5-6
85	SXS 85	2012	2015	2T	K0000KT0K0803	S0000KT0S0803	J0000KT000803	KT 5-6
85	SX 85	2018	>>	2T	K0000KT0K0804	S0000KT0S0804	J0000KT000804	KT 7-8
125	EXC 125	2002	2006	2T	K0000KT0K0870	S0000KT0S0870	J0000KT000870	KT 9-10
125	SX 125	2002	2006	2T	K0000KT0K0870	S0000KT0S0870	J0000KT000870	KT 9-10
125	EXC 125	2007	2016	2T	K0000KT0K0845	S0000KT0S0845	J0000KT000845	KT 11-12
125	SX 125	2007	2015	2T	K0000KT0K0845	S0000KT0S0845	J0000KT000845	KT 11-12
125	SX 125	2016	2022	2T	K0000KT0K0869	S0000KT0S0869	J0000KT000869	KT 13-14
125	XC-W 125	2017	2019	2T	K0000KT0K0869	S0000KT0S0869	J0000KT000869	KT 13-14
125	SX 125	2023	>>	2T	K0000KT0K0879	S0000KT0S0879	J0000KT000879	KT 15-16
125	XC 125	2023	>>	2T	K0000KT0K0879	S0000KT0S0879	J0000KT000879	KT 15-16
150	XC 150	2009	2014	2T	K0000KT0K0845	S0000KT0S0845	J0000KT000845	KT 11-12
150	SX 150	2009	2015	2T	K0000KT0K0845	S0000KT0S0845	J0000KT000845	KT 11-12
150	SX 150	2016	2022	2T	K0000KT0K0869	S0000KT0S0869	J0000KT000869	KT 13-14
150	XC-W 150	2017	2019	2T	K0000KT0K0869	S0000KT0S0869	J0000KT000869	KT 13-14
150	XC-W TPI 150	2020	2022	2T	K0000KT0K0869	S0000KT0S0869	J0000KT000869	KT 13-14

KTM

C.C.	MODEL	SINCE	UNTIL	STROKE	TOP END KIT	SMART KIT	COMPLETE SET	PAGES
150	EXC TPI 150	2020	2022	2T	K0000KT0K0869	S0000KT0S0869	J0000KT000869	KT 13-14
250	SX-F 250	2005	2010	4T	K0000KT0K0806	S0000KT0S0806	J0000KT000806	KT 19-20
250	EXC-F 250	2006	2011	4T	K0000KT0K0806	S0000KT0S0806	J0000KT000806	KT 19-20
250	XCF-W 250	2006	2011	4T	K0000KT0K0806	S0000KT0S0806	J0000KT000806	KT 19-20
250	SX 250	2007	2016	2T	K0000KT0K0805	S0000KT0S0805	J0000KT000805	KT 17-18
250	XC 250	2007	2016	2T	K0000KT0K0805	S0000KT0S0805	J0000KT000805	KT 17-18
250	XC-W 250	2007	2016	2T	K0000KT0K0805	S0000KT0S0805	J0000KT000805	KT 17-18
250	XC-F 250	2007	2009	4T	K0000KT0K0806	S0000KT0S0806	J0000KT000806	KT 19-20
250	SXS-F 250	2007	2008	4T	K0000KT0K0806	S0000KT0S0806	J0000KT000806	KT 19-20
250	EXC 250	2008	2016	2T	K0000KT0K0805	S0000KT0S0805	J0000KT000805	KT 17-18
250	FREERIDE R 250	2014	2017	2T	K0000KT0K0805	S0000KT0S0805	J0000KT000805	KT 17-18
250	EXC 250	2017	2018	2T	K0000KT0K0867	S0000KT0S0867	J0000KT000867	KT 21-22
250	SX 250	2017	2018	2T	K0000KT0K0867	S0000KT0S0867	J0000KT000867	KT 21-22
250	XC 250	2017	2018	2T	K0000KT0K0867	S0000KT0S0867	J0000KT000867	KT 21-22
250	XC-W 250	2017	2018	2T	K0000KT0K0867	S0000KT0S0867	J0000KT000867	KT 21-22
250	XC-W 250 TPI	2017	2019	2T	K0000KT0K0867	S0000KT0S0867	J0000KT000867	KT 21-22
250	EXC 250 TPI	2018	2019	2T	K0000KT0K0867	S0000KT0S0867	J0000KT000867	KT 21-22
250	SX 250	2019	2022	2T	K0000KT0K0867	S0000KT0S0880	J0000KT000880	KT 23-24
250	XC 250	2019	2019	2T	K0000KT0K0867	S0000KT0S0880	J0000KT000880	KT 23-24
250	EXC 250 TPI	2020	2022	2T	K0000KT0K0867	S0000KT0S0880	J0000KT000880	KT 23-24
250	XC 250 TPI	2020	2022	2T	K0000KT0K0867	S0000KT0S0880	J0000KT000880	KT 23-24
250	XC-W 250 TPI	2020	2022	2T	K0000KT0K0867	S0000KT0S0880	J0000KT000880	KT 23-24
250	EXC 250	2023	>>	2T	K0000KT0K0867	S0000KT0S0880	J0000KT000880	KT 23-24
250	XC-W 250	2023	>>	2T	K0000KT0K0867	S0000KT0S0880	J0000KT000880	KT 23-24
300	EXC 300	2008	2016	2T	K0000KT0K0805	S0000KT0S0805	J0000KT000805	KT 17-18

KTM

C.C.	MODEL	SINCE	UNTIL	STROKE	TOP END KIT	SMART KIT	COMPLETE SET	PAGES
300	EXC-E 300	2008	2008	2T	K0000KT0K0805	S0000KT0S0805	J0000KT000805	KT 17-18
300	XC 300	2008	2016	2T	K0000KT0K0805	S0000KT0S0805	J0000KT000805	KT 17-18
300	XC-W 300	2008	2016	2T	K0000KT0K0805	S0000KT0S0805	J0000KT000805	KT 17-18
300	EXC 300	2017	2018	2T	K0000KT0K0867	S0000KT0S0867	J0000KT000867	KT 21-22
300	XC 300	2017	2018	2T	K0000KT0K0867	S0000KT0S0867	J0000KT000867	KT 21-22
300	XC-W 300	2017	2018	2T	K0000KT0K0867	S0000KT0S0867	J0000KT000867	KT 21-22
300	XC-W 300 TPI	2017	2019	2T	K0000KT0K0867	S0000KT0S0867	J0000KT000867	KT 21-22
300	EXC 300 TPI	2018	2019	2T	K0000KT0K0867	S0000KT0S0867	J0000KT000867	KT 21-22
300	XC 300	2019	2019	2T	K0000KT0K0867	S0000KT0S0880	J0000KT000880	KT 23-24
300	EXC 300 TPI	2020	2022	2T	K0000KT0K0867	S0000KT0S0880	J0000KT000880	KT 23-24
300	XC 300 TPI	2020	2022	2T	K0000KT0K0867	S0000KT0S0880	J0000KT000880	KT 23-24
300	XC-W 300 TPI	2020	2022	2T	K0000KT0K0867	S0000KT0S0880	J0000KT000880	KT 23-24
300	EXC 300	2023	>>	2T	K0000KT0K0867	S0000KT0S0880	J0000KT000880	KT 23-24
300	XC-W 300	2023	>>	2T	K0000KT0K0867	S0000KT0S0880	J0000KT000880	KT 23-24
350	SX-F 350	2011	2012	4T	K0000KT0K0807	S0000KT0S0807	J0000KT000807	KT 25-26
350	XC-F 350	2011	2012	4T	K0000KT0K0807	S0000KT0S0807	J0000KT000807	KT 25-26
350	EXC-F 350	2012	2013	4T	K0000KT0K0807	S0000KT0S0807	J0000KT000807	KT 25-26
350	FREERIDE 350	2012	2017	4T	K0000KT0K0807	S0000KT0S0807	J0000KT000807	KT 25-26
350	XCF-W 350	2012	2013	4T	K0000KT0K0807	S0000KT0S0807	J0000KT000807	KT 25-26
400	EXC 400	2009	2011	4T	K0000KT0K0809	S0000KT0S0809	J0000KT000809	KT 29-30
400	XC-W 400	2009	2010	4T	K0000KT0K0809	S0000KT0S0809	J0000KT000809	KT 29-30
450	EXC-F 450	2003	2007	4T	K0000KT0K0842	S0000KT0S0842	J0000KT000842	KT 31-32
450	SX-F 450	2007	2012	4T	K0000KT0K0808	S0000KT0S0808	J0000KT000808	KT 27-28
450	SXS-F 450	2007	2008	4T	K0000KT0K0808	S0000KT0S0808	J0000KT000808	KT 27-28
450	XC-F 450	2008	2009	4T	K0000KT0K0808	S0000KT0S0808	J0000KT000808	KT 27-28

KTM

C.C.	MODEL	SINCE	UNTIL	STROKE	TOP END KIT	SMART KIT	COMPLETE SET	PAGES
450	SMR 450	2008	2012	4T	K0000KTOK0808	S0000KT0S0808	J0000KT000808	KT 27-28
450	EXC-R 450	2008	2008	4T	K0000KTOK0809	S0000KT0S0809	J0000KT000809	KT 29-30
450	XCR-W 450	2008	2008	4T	K0000KTOK0809	S0000KT0S0809	J0000KT000809	KT 29-30
450	EXC 450	2009	2011	4T	K0000KTOK0809	S0000KT0S0809	J0000KT000809	KT 29-30
450	XC-W 450	2009	2011	4T	K0000KTOK0809	S0000KT0S0809	J0000KT000809	KT 29-30
450	RFR 450	2011	2014	4T	K0000KTOK0808	S0000KT0S0808	J0000KT000808	KT 27-28
505	SX-F 505	2007	2008	4T	K0000KTOK0808	S0000KT0S0808	J0000KT000808	KT 27-28
505	XC-F 505	2008	2009	4T	K0000KTOK0808	S0000KT0S0808	J0000KT000808	KT 27-28
530	EXC-R 530	2008	2008	4T	K0000KTOK0809	S0000KT0S0809	J0000KT000809	KT 29-30
530	XCR-W 530	2008	2008	4T	K0000KTOK0809	S0000KT0S0809	J0000KT000809	KT 29-30
530	EXC 530	2009	2011	4T	K0000KTOK0809	S0000KT0S0809	J0000KT000809	KT 29-30
530	XC-W 530	2009	2010	4T	K0000KTOK0809	S0000KT0S0809	J0000KT000809	KT 29-30
450	SX 450	2009	2010	4T	K0000KTOK0808	S0000KT0S0808	J0000KT000808	KT 1-2
505	SX 505	2009	2012	4T	K0000KTOK0808	S0000KT0S0808	J0000KT000808	KT 1-2

XRADICAL
SUPER GASKETS

RIEJU

C.C.	MODEL	SINCE	UNTIL	STROKE	TOP END KIT	SMART KIT	COMPLETE SET	PAGES
200	MR 200 PRO	2020	-	2T	K0000GG0K0863	S0000GG0S0863	J0000GG000863	GG 9-10
200	MR 200 RACING	2020	-	2T	K0000GG0K0863	S0000GG0S0863	J0000GG000863	GG 9-10
200	MR 200 RANGER	2020	-	2T	K0000GG0K0863	S0000GG0S0863	J0000GG000863	GG 9-10
250	MR 250 PRO	2020	-	2T	K0000GG0K0863	S0000GG0S0863	J0000GG000863	GG 9-10
250	MR 250 RACING	2020	-	2T	K0000GG0K0863	S0000GG0S0863	J0000GG000863	GG 9-10
300	MR 300 PRO	2020	-	2T	K0000GG0K0863	S0000GG0S0863	J0000GG000863	GG 9-10
300	MR 300 RACING	2020	-	2T	K0000GG0K0863	S0000GG0S0863	J0000GG000863	GG 9-10
300	MR 300 RANGER	2020	-	2T	K0000GG0K0863	S0000GG0S0863	J0000GG000863	GG 9-10

XRADICAL
SUPER GASKETS

SUZUKI

C.C.	MODEL	SINCE	UNTIL	STROKE	TOP END KIT	SMART KIT	COMPLETE SET	PAGES
65	RM 65	2003	2005	2T	K0000KW0K0817	S0000KW0S0817	J0000KW000817	KW 1-2
85	RM 85	2002	>>	2T	K0000SZ0K0876	S0000SZ0S0876	J0000SZ000876	SZ 1-2
125	RM 125	2001	2012	2T	K0000SZ0K0877	S0000SZ0S0877	J0000SZ000877	SZ 3-4
400	LTZ 400	2003	2018	4T	K0000SZ0K0471	S0000SZ0S0471	J0000SZ000471	SZ 1-2

XRADICAL
SUPER GASKETS

YAMAHA

C.C.	MODEL	SINCE	UNTIL	STROKE	TOP END KIT	SMART KIT	COMPLETE SET	PAGES
65	YZ 65	2018	>>	2T	K0000YM0K0846	S0000YM0S0846	J0000YM000846	YM 1-2
85	YZ 85	2002	2018	2T	K0000YM0K0847	S0000YM0S0847	J0000YM000847	YM 3-4
85	YZ 85	2019	>>	2T	K0000YM0K0881	S0000YM0S0881	J0000YM000881	YM 5-6
125	YZ 125	2005	2021	2T	K0000YM0K0849	S0000YM0S0849	J0000YM000849	YM 7-8
125	YZ 125	2022	>>	2T	K0000YM0K0882	S0000YM0S0882	J0000YM000882	YM 9-10
250	YZ 250 F	2001	2013	4T	K0000YM0K0810	S0000YM0S0810	J0000YM000810	YM 13-14
250	WR 250 F	2001	2014	4T	K0000YM0K0810	S0000YM0S0810	J0000YM000810	YM 13-14
250	YZ 250	2003	>>	2T	K0000YM0K0851	S0000YM0S0851	J0000YM000851	YM 11-12
250	YZ 250 F	2014	2018	4T	K0000YM0K0811	S0000YM0S0811	J0000YM000811	YM 15-16
250	YZ 250 FX	2015	2017	4T	K0000YM0K0811	S0000YM0S0811	J0000YM000811	YM 15-16
250	WR 250 F	2015	2018	4T	K0000YM0K0811	S0000YM0S0811	J0000YM000811	YM 15-16
250	YZ 250 X	2016	2022	2T	K0000YM0K0851	S0000YM0S0851	J0000YM000851	YM 11-12
450	YZ 450 F	2003	2005	4T	K0000YM0K0377	S0000YM0S0377	J0000YM000377	YM 21-22
450	WR 450 F	2004	2006	4T	K0000YM0K0818	S0000YM0S0818	J0000YM000818	YM 17-18
450	YZ 450 F	2006	2009	4T	K0000YM0K0812	S0000YM0S0812	J0000YM000812	YM- 23-24
450	WR 450 F	2007	2015	4T	K0000YM0K0819	S0000YM0S0819	J0000YM000819	YM 19-20
450	YZ 450 F	2010	2013	4T	K0000YM0K0815	S0000YM0S0815	J0000YM000815	YM 25-26
450	YZ 450 F	2014	2017	4T	K0000YM0K0816	S0000YM0S0816	J0000YM000816	YM 27-28
450	YZ 450 FX	2016	2017	4T	K0000YM0K0816	S0000YM0S0816	J0000YM000816	YM 27-28
450	WR 450 F	2016	2018	4T	K0000YM0K0816	S0000YM0S0816	J0000YM000816	YM 27-28
200	YFS 200 BLASTER	1988	2006	2T	K0000YM0K0378	S0000YM0S0378	J0000YM000378	YM 1-2
350	YFZ 350 BANSHEE	1987	2012	2T	K0000YM0K0369	S0000YM0S0369	J0000YM000369	YM 3-4
450	YFZ 450	2004	2013	4T	K0000YM0K0377	S0000YM0S0377	J0000YM000377	YM 5-6
660	YFM 660 RAPTOR	2001	2005	4T	K0000YM0K0379	S0000YM0S0379	J0000YM000379	YM 7-8

XRADICAL ***SUPER GASKETS***



ARTEIN PART No.	DESCRIPTION	UNITS	TOP END KIT K0000BTOK0872	SMART KIT S0000BTOS0872	COMPLETE SET J0000BT000872	ORIGINAL PART No.
X560006000200	O-RING (CYLINDER HEAD GASKET, INNER) (125 CC)	1	▪	▪	▪	C02.06.060.00.00
X560006700200	O-RING (CYLINDER HEAD GASKET, INNER) (200 CC)	1	▪	▪	▪	C02.06.064.00.00
X560009200200	O-RING (CYLINDER HEAD GASKET, OUTER)	1	▪	▪	▪	C02.06.061.00.00
X560002200250	O-RING (CYLINDER HEAD GASKET, UPPER)	1	▪	▪	▪	10.66505.0000
P02D000005562	CYLINDER BASE GASKET (0,25 MM)	1	▪	▪	▪	035.11.024.00.00
P02E000005562	CYLINDER BASE GASKET (0,3 MM)	1	▪	▪	▪	035.11.010.00.00
P02F000005562	CYLINDER BASE GASKET (0,4 MM)	1	▪	▪	▪	035.11.011.00.00
P02G000005562	CYLINDER BASE GASKET (0,5 MM)	1	▪	▪	▪	035.11.012.00.00
P02H000005562	CYLINDER BASE GASKET (0,6 MM)	1	▪	▪	▪	035.11.025.00.00
X560003800300	EXHAUST GASKET (125-2018-2019)	2	▪	▪	▪	C02.06.065.00.00
X560004300300	EXHAUST GASKET (125-200 CC)	2	▪	▪	▪	1.066.930.0000
A820007012020	WASHER (CYLINDER HEAD)	6	▪	▪	▪	2.745.100.0000
A820006010100	WASHER (CYLINDER HEAD)	1	▪	▪	▪	27.40495.0000
P025000005566	EXHAUST VALVE GASKET, RIGHT SIDE (125-200 CC)	1	▪	▪	▪	035.11.033.00.00
P025000005567	EXHAUST VALVE GASKET, RIGHT SIDE (125 2018-2019)	1	▪	▪	▪	035.11.004.00.00
P015000005563	REED VALVE GASKET	1	▪	▪	▪	035.01.019.00.00
P025000005564	EXHAUST VALVE COVER GASKET, FRONT SIDE (125 2018-2019)	1	▪	▪	▪	035.11.017.00.00
P025000005565	EXHAUST VALVE COVER GASKET, FRONT SIDE (125-200 CC)	1	▪	▪	▪	035.11.034.00.00
P025000005568	EXHAUST VALVE COVER GASKET, LEFT SIDE	1	▪	▪	▪	035.11.018.00.00
P018000005571	CLUTCH COVER GASKET	1	▪	▪	▪	035.01.009.00.00
P025000005572	FRICTION DISC COVER GASKET (125-200 CC)	1	▪	▪	▪	035.01.008.00.59
X520014529178	FRICTION DISC COVER GASKET (125 2018-2019)	1	▪	▪	▪	C02.06.059.00.00
X520001100250	O-RING (OIL DRAIN)	1	▪	▪	▪	10.66164.0000
P014000005574	WATER PUMP COVER GASKET	1	▪	▪	▪	035.01.023.00.00
P014000005575	WATER PUMP COVER GASKET	1	▪	▪	▪	035.01.024.00.00
A820006010100	WASHER (WATER PUMP)	2	▪	▪	▪	27.40495.0000
X520001786262	O-RING (WATER HOSE)	2	▪	▪	▪	C02.06.052.00.00
P003000005569	CRANKCASE GASKET	1	▪	▪	▪	035.01.003.00.00
P016000005573	IGNITION COVER GASKET	1	▪	▪	▪	035.01.015.00.00
X520002195178	O-RING (CRANKSHAFT)	1	▪	▪	▪	10.66490.0000
X520003200200	O-RING (THERMOSTAT)	1	▪	▪	▪	10.66830.0000
X520001237262	O-RING (EXHAUST VALVE LEVER)	1	▪	▪	▪	10.66296.0000
X520002400200	O-RING (EXHAUST VALVE LEVER)	1	▪	▪	▪	10.66540.0000
X520002512178	O-RING (FRONT SPROCKET)	1	▪	▪	▪	10.66620.0000
X520002350178	O-RING (CLUTCH SLAVE)	1	▪	▪	▪	10.66520.0000
X520002189262	O-RING (CLUTCH SLAVE)	1	▪	▪	▪	10.66510.0000
X520001717178	O-RING (OIL FILLER CAP)	1	▪	▪	▪	10.66321.0000



P02D000005562 | 035.11.024.00.00 (0,25 mm)
P02E000005562 | 035.11.010.00.00 (0,3 mm)
P02F000005562 | 035.11.011.00.00 (0,4 mm)
P02G000005562 | 035.11.012.00.00 (0,5 mm)
P02H000005562 | 035.11.025.00.00 (0,6 mm) **K S J**

CYLINDER BASE GASKET



P003000005569 | 035.01.003.00.00 **J**

CRANKCASE GASKET

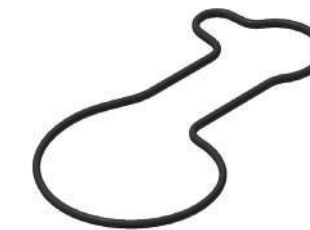

P014000005574 | 035.01.023.00.00 **S J**

WATER PUMP GASKET



P014000005575 | 035.01.024.00.00 **S J**

WATER PUMP GASKET

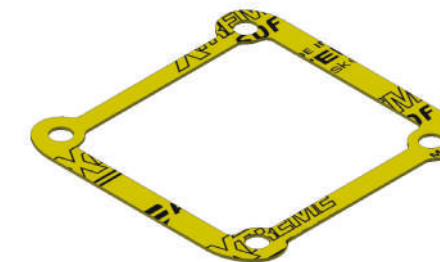

P015000005563 | 035.01.019.00.00 **K S J**

REED VALVE GASKET



P016000005573 | 10.66164.0000 **J**

IGNITION COVER GASKET

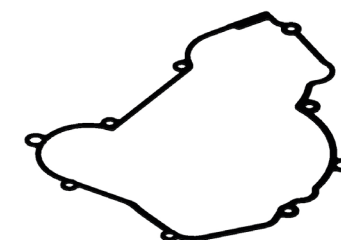

P018000005571 | 035.01.009.00.00 **S J**

CLUTCH COVER GASKET



P025000005564 | 035.11.017.00.00 **K S J**

EXHAUST VALVE GASKET, FRONT SIDE (RR125 2018-2019)



P025000005565 | 035.11.034.00.00 **K S J**

EXHAUST VALVE GASKET, FRONT SIDE (125-200 CC)

ARTEIN PART No.	DESCRIPTION	UNITS	TOP END KIT K0000BTOK0866	SMART KIT S0000BTOS0866	COMPLETE SET J0000BT000866	ORIGINAL PART No.
X560007300200	O-RING (CYLINDER HEAD GASKET, INNER) (250 CC)	1	▪	▪	▪	10.66972.000
X560007800200	O-RING (CYLINDER HEAD GASKET, INNER) (300 CC)	1	▪	▪	▪	10.66973.000
X560010500200	O-RING (CYLINDER HEAD GASKET, OUTER) (250-300 CC)	1	▪	▪	▪	10.66978.000
P02E000005506	CYLINDER BASE GASKET (0,3 MM)	1	▪	▪	▪	026.11.025.00.00
P02F000005506	CYLINDER BASE GASKET (0,4 MM)	1	▪	▪	▪	026.11.026.00.00
P02G000005506	CYLINDER BASE GASKET (0,5 MM)	1	▪	▪	▪	026.11.027.00.00
P02H000005506	CYLINDER BASE GASKET (0,6 MM)	1	▪	▪	▪	026.11.028.00.00
X560004300300	EXHAUST GASKET	2	▪	▪	▪	10.66930.000
P025000005508	EXHAUST VALVE COVER GASKET, LEFT SIDE	2	▪	▪	▪	026.11.005.00.00
P025000005509	EXHAUST VALVE COVER GASKET, RIGHT SIDE	1	▪	▪	▪	026.11.003.00.00
P012000005507	EXHAUST VALVE COVER GASKET, FRONT SIDE	1	▪	▪	▪	026.11.038.00.00
A820008016150	WASHER (CYLINDER HEAD GASKET)	6	▪	▪	▪	026.11.010.00.00
P015000005510	REED VALVE GASKET	2	▪	▪	▪	026.01.010.00.00
P018000005511	CLUTCH COVER GASKET	1	▪	▪	▪	026.01.005.00.00
P025000005512	FRICTION DISC COVER GASKET	1	▪	▪	▪	26.01.041.00.00
P014000005516	WATER PUMP COVER GASKET	1	▪	▪	▪	026.01.036.00.00
P014000005517	WATER PUMP SEAL	1	▪	▪	▪	026.01.035.00.00
A820006010100	WASHER (WATER PUMP / CLUTCH COVER)	2	▪	▪	▪	27.40495.000
X520001786262	O-RING (WATER HOSE SEAL)	2	▪	▪	▪	C02.06.052.00.00
X520001100250	O-RING (OIL DRAIN)	1	▪	▪	▪	10.66164.000
P003000005513	CRANKCASE GASKET	1	▪	▪	▪	026.01.003.00.00
P016000005514	IGNITION COVER GASKET	1	▪	▪	▪	026.01.053.00.00
P025000005515	CLUTCH SLAVE GASKET	1	▪	▪	▪	006.03.085.00.00
X520003300150	O-RING (CLUTCH SLAVE)	1	▪	▪	▪	10.66840.000
X520002350178	O-RING (CLUTCH SLAVE)	1	▪	▪	▪	10.66520.000
X520001237262	O-RING (EXHAUST VALVE LEVER)	1	▪	▪	▪	10.66296.000
X520002400200	O-RING (EXHAUST VALVE LEVER / FRONT SPROKET)	2	▪	▪	▪	10.66540.000
X520002512178	O-RING (PRIMARY GEAR)	1	▪	▪	▪	10.66620.000
X520001717178	O-RING (OIL FILLER CAP)	1	▪	▪	▪	10.66321.000



P02E000005506 | 026.11.025.00.00 (0,3 mm)
P02F000005506 | 026.11.026.00.00 (0,4 mm)
P02G000005506 | 026.11.027.00.00 (0,5 mm)
P02H000005506 | 026.11.028.00.00 (0,6 mm) **K S J**

CYLINDER BASE GASKET



P015000005510 | 026.01.010.00.00 **K S J**

REED VALVE GASKET

2 UNITS

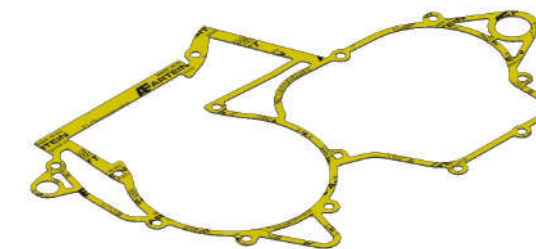

P003000005513 | 026.01.003.00.00 **J**

CRANKCASE GASKET



P018000005511 | 026.01.005.00.00 **S J**

CLUTCH COVER GASKET

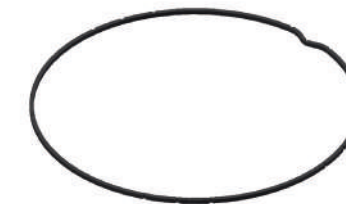

P025000005512 | 026.01.041.00.00 **S J**

FRICTION DISC COVER GASKET

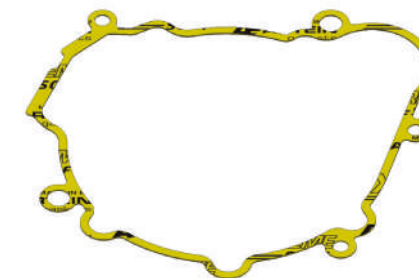

P016000005514 | 026.01.053.00.00 **J**

IGNITION COVER GASKET



P025000005508 | 026.11.005.00.00 **K S J**

EXHAUST VALVE COVER GASKET, LEFT SIDE

2 UNITS



P025000005509 | 026.11.003.00.00 **K S J**

EXHAUST VALVE COVER GASKET, RIGHT SIDE



P014000005516 | 026.01.036.00.00 **S J**

WATER PUMP COVER GASKET

ARTEIN PART No.	DESCRIPTION	UNITS	TOP END KIT K0000GGOK0859	SMART KIT S0000GGOS0859	COMPLETE SET J0000GG000859	ORIGINAL PART No.
X520009170178	O-RING (CYLINDER HEAD GASKET, OUTER)	1	▪	▪	▪	ME120116060
X560006322178	O-RING (CYLINDER HEAD GASKET, INNER)	1	▪	▪	▪	ME120116065
P02B000005453	CYLINDER BASE GASKET (0,15 MM)	1	▪	▪	▪	ME120144010
P02E000005453	CYLINDER BASE GASKET (0,3 MM)	1	▪	▪	▪	ME120144009
P02G000005453	CYLINDER BASE GASKET (0,5 MM)	1	▪	▪	▪	ME120144000
P012000005456	EXHAUST GASKET	1	▪	▪	▪	ME120144012
P025000005454	EXHAUST VALVE COVER GASKET, RIGHT SIDE	1	▪	▪	▪	ME120144007
X560004400300	O-RING (EXHAUST PIPE)	2	▪	▪	▪	BE250526006
A820008016150	WASHER (CYLINDER HEAD)	5	▪	▪	▪	T4008516
P015000005457	REED VALVE GASKET	1	▪	▪	▪	ME120144005
P015000005458	REED VALVE GASKET	1	▪	▪	▪	ME120644005
P025000005455	EXHAUST VALVE COVER GASKET, FRONT SIDE	1	▪	▪	▪	ME120144006
P018000005461	CLUTCH COVER GASKET	1	▪	▪	▪	ME120144002
P025000005462	FRICTION DISC COVER GASKET	1	▪	▪	▪	ME120144003
A820012018150	WASHER (OIL DRAIN)	2	▪	▪	▪	ME25810030
P014000005459	WATER PUMP COVER GASKET	1	▪	▪	▪	ME120144008
A770006010150	WASHER (WATER PUMP)	1	▪	▪	▪	T4006010
P003000005460	CRANKCASE GASKET	1	▪	▪	▪	ME120144001
P016000005463	IGNITION COVER GASKET	1	▪	▪	▪	ME120144004
X520002830178	O-RING (CENTRIFUGAL COVER)	1	▪	▪	▪	ME120332086
X520001200200	O-RING (OIL DRAIN)	1	▪	▪	▪	ME25610026

XRADICAL
SUPER GASKETS



P02B000005453 | ME120144010 (0,15 mm)
P02E000005453 | ME120144009 (0,3 mm)
P02G000005453 | ME120144000 (0,5 mm) **K S J**
CYLINDER BASE GASKET



P012000005456 | ME120144012 **K S J**
EXHAUST GASKET

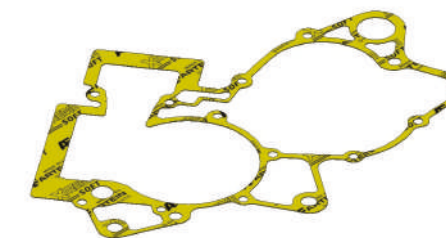

P003000005460 | ME120144001 **J**
CRANKCASE GASKET

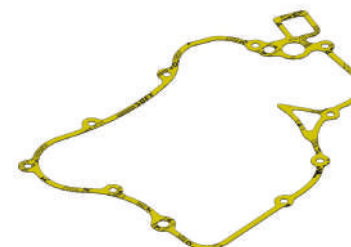

P018000005461 | ME120144002 **S J**
CLUTCH COVER GASKET



P025000005462 | ME120144003 **S J**
FRICTION DISC COVER GASKET



P016000005463 | ME120144004 **J**
IGNITION COVER GASKET

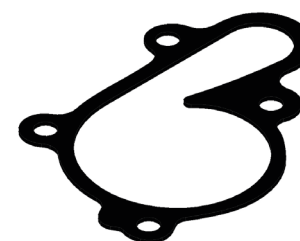

P014000005459 | ME120144008 **S J**
WATER PUMP COVER GASKET



P025000005454 | ME120144007 **K S J**
EXHAUST VALVE COVER GASKET, RIGHT SIDE



P025000005455 | ME120144006 **K S J**
EXHAUST VALVE COVER GASKET, FRONT SIDE

ARTEIN PART No.	DESCRIPTION	UNITS	TOP END KIT K0000GGOK0860	SMART KIT S0000GGOS0860	COMPLETE SET J0000GG000860	ORIGINAL PART No.
X520010132178	O-RING (CYLINDER HEAD GASKET, OUTER) (200 CC)	1	▪	▪	▪	M01619135
X560007270178	O-RING (CYLINDER HEAD GASKET, INNER) (200-250 CC)	1	▪	▪	▪	ME25916065
X520010767178	O-RING (CYLINDER HEAD GASKET, OUTER) (250-300 CC)	1	▪	▪	▪	ME25916060
X560007592178	O-RING (CYLINDER HEAD GASKET, INNER) (300 CC)	1	▪	▪	▪	ME30916065
P02B000005464	CYLINDER BASE GASKET (0,15 MM)	1	▪	▪	▪	ME25644010
P02E000005464	CYLINDER BASE GASKET (0,3 MM)	1	▪	▪	▪	ME25644009
P02G000005464	CYLINDER BASE GASKET (0,5 MM)	1	▪	▪	▪	ME25644000
P012000005468	EXHAUST GASKET	1	▪	▪	▪	ME25644012
P025000005465	EXHAUST VALVE COVER GASKET, LEFT SIDE	1	▪	▪	▪	ME25644006
P025000005466	EXHAUST VALVE COVER GASKET, RIGHT SIDE	2	▪	▪	▪	ME25644007
X560004400300	O-RING (EXHAUST PIPE)	2	▪	▪	▪	BE250526006
A820008016150	WASHER (CYLINDER HEAD)	6	▪	▪	▪	T4008516
P025000005484	THERMOSTAT COVER GASKET (1998-2001)	1	▪	▪	▪	ME25944011
P025000005467	THERMOSTAT COVER GASKET (2002-2004)	1	▪	▪	▪	ME250344011
P015000005469	REED VALVE GASKET	1	▪	▪	▪	ME25644005
P018000005474	CLUTCH COVER GASKET	1	▪	▪	▪	ME25644002
P025000005475	FRICTION DISC COVER GASKET	1	▪	▪	▪	ME25644003
X520001200200	O-RING (OIL DRAIN)	1	▪	▪	▪	ME25610026
A820012018150	WASHER (OIL DRAIN)	1	▪	▪	▪	ME25810030
P014000005485	WATER PUMP COVER GASKET (1998)	1	▪	▪	▪	ME25644008
P014000005472	WATER PUMP COVER GASKET (1999-2004)	1	▪	▪	▪	ME25944008
A770006010150	WASHER (WATER PUMP)	1	▪	▪	▪	T4006010
P003000005486	CRANKCASE GASKET	1	▪	▪	▪	ME25944001
P016000005487	IGNITION COVER GASKET	1	▪	▪	▪	ME25644004
X520003200200	O-RING (CLUTCH SLAVE)	1	▪	▪	▪	ME25632024
X520002500200	O-RING (FRONT SPROCKET)	2	▪	▪	▪	ME25632025

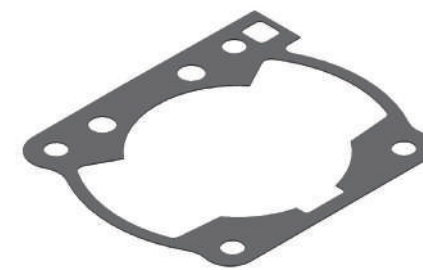

P02B000005464 | ME25644010 (0,15 mm)
P02E000005464 | ME25644009 (0,3 mm)
P02G000005464 | ME25644000 (0,5 mm) **K S J**

CYLINDER BASE GASKET



P012000005468 | ME25644012 **K S J**

EXHAUST GASKET



P003000005486 | ME25944001 **J**

CRANKCASE GASKET

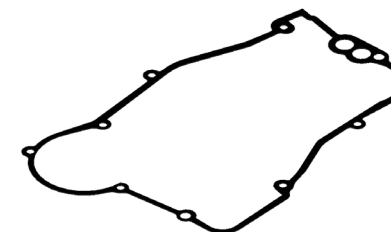

P018000005474 | ME25644002 **S J**

CLUTCH COVER GASKET

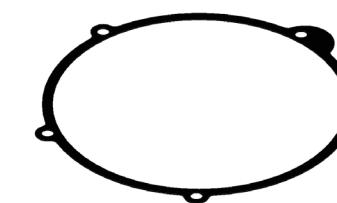

P025000005475 | ME25644003 **S J**

FRICTION DISC COVER GASKET



P016000005487 | ME25644004 **J**

IGNITION COVER GASKET

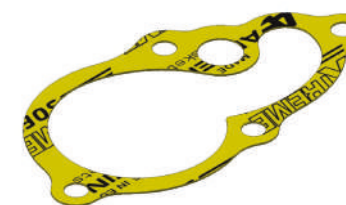

P014000005485 | ME25644008
P014000005472 | ME25944008 **S J**

WATER PUMP COVER GASKET



P025000005466 | ME25644007 **K S J**

EXHAUST VALVE COVER GASKET, RIGHT SIDE

2 UNITS



P025000005465 | ME25644006 **K S J**

EXHAUST VALVE COVER GASKET, LEFT SIDE

ARTEIN PART No.	DESCRIPTION	UNITS	TOP END KIT K0000GGOK0861	SMART KIT S0000GGOS0861	COMPLETE SET J0000GG000861	ORIGINAL PART No.
X520010132178	O-RING (CYLINDER HEAD GASKET, OUTER) (200 CC)	1	▪	▪	▪	M01619135
X560007270178	O-RING (CYLINDER HEAD GASKET, INNER) (200-250 CC)	1	▪	▪	▪	ME25916065
X520010767178	O-RING (CYLINDER HEAD GASKE, OUTER) (250-300 CC)	1	▪	▪	▪	ME25916060
X560007592178	O-RING (CYLINDER HEAD GASKET, INNER) (300 CC)	1	▪	▪	▪	ME30916065
P02B000005464	CYLINDER BASE GASKET (0,15 MM)	1	▪	▪	▪	ME25644010
P02E000005464	CYLINDER BASE GASKET (0,3 MM)	1	▪	▪	▪	ME25644009
P02G000005464	CYLINDER BASE GASKET (0,5 MM)	1	▪	▪	▪	ME25644000
P012000005468	EXHAUST GASKET	1	▪	▪	▪	ME25644012
P025000005465	EXHAUST VALVE COVER GASKET, LEFT SIDE	1	▪	▪	▪	ME25644006
P025000005466	EXHAUST VALVE COVER GASKET, RIGHT SIDE	2	▪	▪	▪	ME25644007
X560004400300	O-RING (EXHAUST PIPE)	2	▪	▪	▪	BE250526006
A820008016150	WASHER (CYLINDER HEAD)	6	▪	▪	▪	T4008516
P025000005467	THERMOSTAT COVER GASKET	1	▪	▪	▪	ME250344011
A820006010150	WASHER (THERMOSTAT COVER)	2	▪	▪	▪	ME25916002
P015000005469	REED VALVE GASKET	1	▪	▪	▪	ME25644005
P015000005470	REED VALVE GASKET	1	▪	▪	▪	ME250644005
P015000005471	REED VALVE GASKET	1	▪	▪	▪	ME250644105
P018000005474	CLUTCH COVER GASKET	1	▪	▪	▪	ME25644002
P025000005475	FRICTION DISC COVER GASKET	1	▪	▪	▪	ME25644003
X520001200200	O-RING (OIL DRAIN)	1	▪	▪	▪	ME25610026
A820012018150	WASHER (OIL DRAIN)	1	▪	▪	▪	ME25810030
P014000005472	WATER PUMP COVER GASKET	1	▪	▪	▪	ME25944008
A770006010150	WASHER (WATER PUMP)	1	▪	▪	▪	T4006010
P003000005473	CRANKCASE GASKET	1	▪	▪	▪	ME9000013012
P016000005476	IGNITION COVER GASKET	1	▪	▪	▪	ME250544004
X520003200200	O-RING (CLUTCH SLAVE)	1	▪	▪	▪	ME25632024
X520002500200	O-RING (FRONT SPROCKET)	2	▪	▪	▪	ME25632025

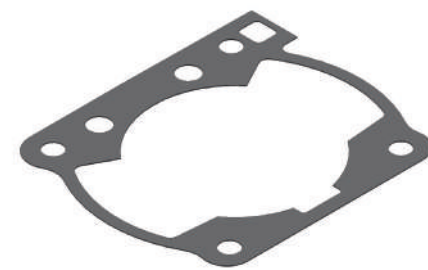

P02B000005464 | ME25644010 (0,15 mm)
P02E000005464 | ME25644009 (0,3 mm)
P02G000005464 | ME25644000 (0,5 mm) **K S J**

CYLINDER BASE GASKET



P012000005468 | ME25644012 **K S J**

EXHAUST GASKET



P003000005473 | ME9000013012 **J**

CRANKCASE GASKET

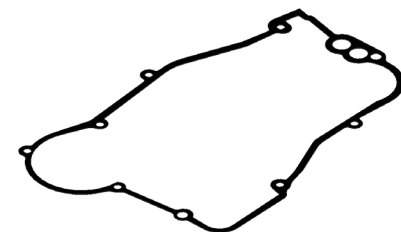

P018000005474 | ME25644002 **S J**

CLUTCH COVER GASKET

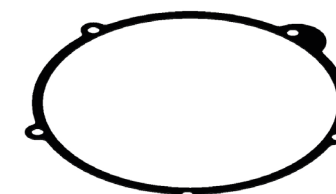

P025000005475 | ME25644003 **S J**

FRICTION DISC COVER GASKET



P016000005476 | ME250544004 **J**

IGNITION COVER GASKET



P014000005472 | ME25944008 **S J**

WATER PUMP COVER GASKET



P025000005466 | ME25644007 **K S J**

EXHAUST VALVE COVER GASKET, RIGHT SIDE

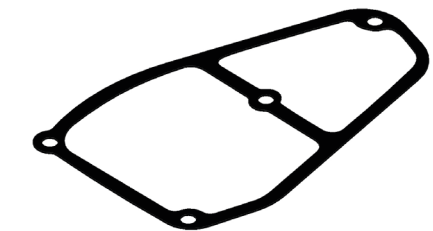
2 UNITS

P025000005465 | ME25644006 **K S J**

EXHAUST VALVE COVER GASKET, LEFT SIDE

ARTEIN PART No.	DESCRIPTION	UNITS	TOP END KIT K0000GGOK0862	SMART KIT S0000GGOS0862	COMPLETE SET J0000GG000862	ORIGINAL PART No.
X560007270178	O-RING (CYLINDER HEAD GASKET, INNER) (200-250 CC)	1	▪	▪	▪	ME25916065
X520010767178	O-RING (CYLINDER HEAD GASKET, OUTER)	1	▪	▪	▪	ME25916060
X560007592178	O-RING (CYLINDER HEAD GASKET, INNER) (300 CC)	1	▪	▪	▪	ME30916065
P02G000005501	CYLINDER BASE GASKET	1	▪	▪	▪	ME44000GG-CLJ-1
P012000005468	EXHAUST GASKET	1	▪	▪	▪	ME25644012
P025000005478	EXHAUST VALVE COVER GASKET, LEFT SIDE	1	▪	▪	▪	ME440063013
P025000005466	EXHAUST VALVE COVER GASKET, RIGHT SIDE	1	▪	▪	▪	ME25644007
P025000005479	EXHAUST VALVE SPACER GASKET, RIGHT SIDE	1	▪	▪	▪	ME70055GG-CEQ-1
X560004400300	O-RING (EXHAUST PIPE)	2	▪	▪	▪	BE250526006
A820008012150	WASHER (CYLINDER HEAD)	6	▪	▪	▪	T4008012
P025000005467	THERMOSTAT COVER GASKET	1	▪	▪	▪	ME250344011
A820006010150	WASHER (THERMOSTAT COVER)	2	▪	▪	▪	ME25916002
P015000005471	REED VALVE GASKET	1	▪	▪	▪	ME250644105
P015000005480	REED VALVE GASKET	1	▪	▪	▪	ME94600GG-CAB-1
P018000005474	CLUTCH COVER GASKET	1	▪	▪	▪	ME25644002
P025000005482	FRICTION DISC COVER GASKET	1	▪	▪	▪	ME22015GG-CAB-1
A820012018150	WASHER (OIL DRAIN)	2	▪	▪	▪	ME25810030
P014000005502	WATER PUMP COVER GASKET	1	▪	▪	▪	ME57010GG-CAB-1
A770006010150	WASHER (WATER PUMP)	1	▪	▪	▪	T4006010
P003000005481	CRANKCASE GASKET	1	▪	▪	▪	ME94000GG-CAB-1
P016000005483	IGNITION COVER GASKET	1	▪	▪	▪	ME94500GG-CAB-1
X520002500200	O-RING (FRONT SPROCKET)	2	▪	▪	▪	ME25632025
X520002300500	O-RING (PRIMARY GEAR)	1	▪	▪	▪	ME21180GG-CAB-1



▲ P02G000005501 | ME44000GG-CLJ-1 **K S J**
CYLINDER BASE GASKET



▲ P012000005468 | ME25644012 **K S J**
EXHAUST GASKET

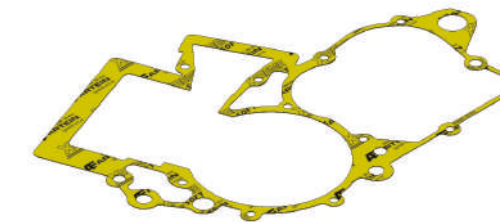

▲ P003000005481 | ME94000GG-CAB-1 **J**
CRANKCASE GASKET

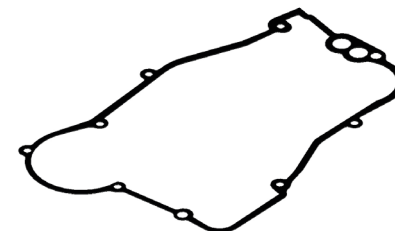

▲ P018000005474 | ME25644002 **S J**
CLUTCH COVER GASKET



▲ P025000005482 | ME22015GG-CAB-1 **S J**
FRICTION DISC COVER GASKET



▲ P016000005483 | ME94500GG-CAB-1 **J**
IGNITION COVER GASKET



▲ P014000005502 | ME57010GG-CAB-1 **S J**
WATER PUMP COVER GASKET



▲ P025000005479 | ME70055GG-CEQ-1 **K S J**
EXHAUST VALVE SPACER, RIGHT SIDE

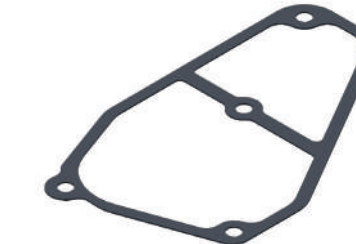

▲ P025000005478 | ME440063013 **K S J**
EXHAUST VALVE COVER GASKET, LEFT SIDE

XRADICAL
SUPER GASKETS

ARTEIN PART No.	DESCRIPTION	UNITS	TOP END KIT K0000GGOK0863	SMART KIT S0000GGOS0863	COMPLETE SET J0000GG000863	ORIGINAL PART No.
X560007270178	O-RING (CYLINDER HEAD GASKET, INNER) (200-250 CC)	1	▪	▪	▪	ME25916065
X520010767178	O-RING (CYLINDER HEAD GASKET, OUTER)	1	▪	▪	▪	ME25916060
X560007592178	O-RING (CYLINDER HEAD GASKET, INNER) (300 CC)	1	▪	▪	▪	ME30916065
P02G000005501	CYLINDER BASE GASKET	1	▪	▪	▪	ME44000GG-CLJ-1
P012000005468	EXHAUST GASKET	1	▪	▪	▪	ME25644012
P025000005478	EXHAUST VALVE COVER GASKET, LEFT SIDE	1	▪	▪	▪	ME440063013
P025000005479	EXHAUST VALVE SPACER GASKET, RIGHT SIDE	1	▪	▪	▪	ME70055GG-CEQ-1
X560004400300	O-RING (EXHAUST PIPE)	2	▪	▪	▪	BE250526006
A820008016150	WASHER (CYLINDER HEAD)	6	▪	▪	▪	T4008516
P025000005466	EXHAUST VALVE COVER GASKET, RIGHT SIDE	2	▪	▪	▪	ME25644007
P015000005480	REED VALVE GASKET	1	▪	▪	▪	ME94600GG-CAB-1
P015000005488	REED VALVE GASKET	1	▪	▪	▪	ME44105GG-CLJ-1
P018000005474	CLUTCH COVER GASKET	1	▪	▪	▪	ME25644002
P025000005482	FRICTION DISC COVER GASKET	1	▪	▪	▪	ME22015GG-CAB-1
A820012018150	WASHER (OIL DRAIN)	2	▪	▪	▪	ME25810030
P014000005502	WATER PUMP COVER GASKET	1	▪	▪	▪	ME57010GG-CAB-1
A770006010150	WASHER (WATER PUMP)	1	▪	▪	▪	T4006010
P003000005489	CRANKCASE GASKET	1	▪	▪	▪	ME94000GG-CLJ-1
P031000005490	ELECTRIC START COVER GASKET	1	▪	▪	▪	EE80135GG-CBR-1
P016000005483	IGNITION COVER GASKET (GG 2018-2019)	1	▪	▪	▪	ME94500GG-CAB-1
P016000005579	IGNITION COVER GASKET (RIEJU)	1	▪	▪	▪	ME94500GG-CSK-1
X520002500200	O-RING (FRONT SPROCKET)	2	▪	▪	▪	ME25632025
X520002300500	O-RING (PRIMARY GEAR)	1	▪	▪	▪	ME21180GG-CAB-1

XRADICAL
SUPER GASKETS



▲ P02G000005501 | ME44000GG-CLJ-1 **K S J**
CYLINDER BASE GASKET



▲ P012000005468 | ME25644012 **K S J**
EXHAUST GASKET

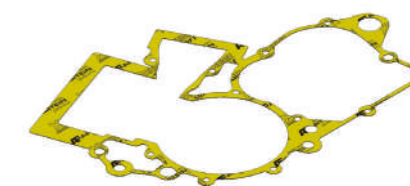

▲ P003000005489 | ME94000GG-CLJ-1 **J**
CRANKCASE GASKET

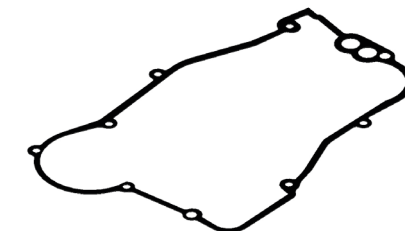

▲ P018000005474 | ME25644002 **S J**
CLUTCH COVER GASKET



▲ P025000005482 | ME22015GG-CAB-1 **S J**
FRICTION DISC COVER GASKET



▲ P016000005483 | ME94500GG-CAB-1 (GAS GAS) **J**
▲ P016000005579 | ME94500GG-CSK-1 (RIEJU)
IGNITION COVER GASKET



▲ P014000005502 | ME57010GG-CAB-1 **S J**
WATER PUMP COVER GASKET



▲ P025000005479 | ME70055GG-CEQ-1 **K S J**
EXHAUST VALVE SPACER, RIGHT SIDE



▲ P025000005478 | ME440063013 **K S J**
EXHAUST VALVE GASKET, LEFT SIDE

ARTEIN PART No.	DESCRIPTION	UNITS	TOP END KIT K0000HN0K0871	SMART KIT S0000HN0S0871	COMPLETE SET J0000HN000871	ORIGINAL PART No.
P001000005560	CYLINDER HEAD GASKET	1	▪	▪	▪	12251-KZ4-701
P02F000005546	CYLINDER BASE GASKET (0,4 MM)	1	▪	▪	▪	-
P02G000005546	CYLINDER BASE GASKET (0,5 MM)	1	▪	▪	▪	12191-KZ4-620
P02H000005546	CYLINDER BASE GASKET (0,6 MM)	1	▪	▪	▪	-
P012000005372	EXHAUST GASKET	1	▪	▪	▪	18291-KZ4-700
A801006012150	WASHER (CYLINDER)	1	▪	▪	▪	90430-PD6-003
P025000005548	EXHAUST VALVE COVER GASKET, RIGHT SIDE	1	▪	▪	▪	12108-KZ4-620
P025000005547	EXHAUST VALVE COVER GASKET, LEFT SIDE	1	▪	▪	▪	12109-KZ4-620
P025000005549	EXHAUST VALVE GASKET, UPPER	2	▪	▪	▪	12112-KZ4-620
P015000005369	REED VALVE GASKET	1	▪	▪	▪	14132-KZ4-620
X520001900300	O-RING (WATER HOSE SEAL)	1	▪	▪	▪	91312-KE7-003
P018000005376	CLUTCH COVER GASKET	1	▪	▪	▪	11394-KZ4-A90
X520015150178	O-RING (FRICTION DISC COVER GASKET)	1	▪	▪	▪	91311-KS6-700
P014000005551	WATER PUMP COVER GASKET	2	▪	▪	▪	19229-KZ4-620
A801006012150	WASHER (CLUTCH COVER/WATER PUMP/CRANKCASE)	4	▪	▪	▪	90430-PD6-003
A801012018150	WASHER (OIL DRAIN)	1	▪	▪	▪	94109-12000
P016000005378	IGNITION COVER GASKET	1	▪	▪	▪	11352-KS6-700
P003000005550	CRANKCASE GASKET	1	▪	▪	▪	11191-KS4-620
X520002000150	O-RING (FRONT SPROCKET)	1	▪	▪	▪	91351-KA3-711
X520001580240	O-RING (OIL FILLER CAP)	1	▪	▪	▪	91304-MJ0-003

XRADICAL
SUPER GASKETS



P02F000005546 (0,4 mm)
P02G000005546 (0,5 mm)
P02H000005546 (0,6 mm)
12191-KZ4-620
CYLINDER BASE GASKET

K S J



P001000005560 | 12251-KZ4-701
CYLINDER HEAD GASKET

K S J

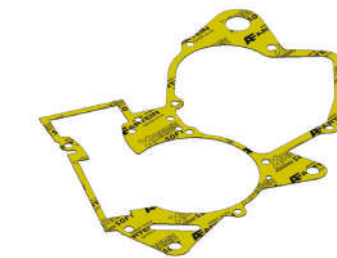

P003000005550 | 11191-KS4-620
CRANKCASE GASKET

J

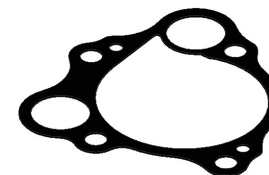

P014000005551 | 19229-KZ4-620
WATER PUMP COVER GASKET

S J

2 UNITS

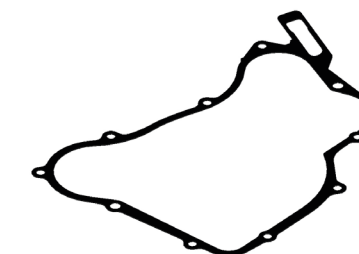

P018000005376 | 11394-KZ4-A90
CLUTCH COVER GASKET

S J



P016000005378 | 11352-KS6-700
IGNITION COVER GASKET

J

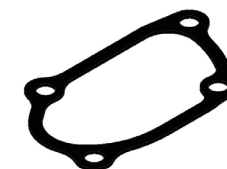

P025000005547 | 12109-KZ4-620
EXHAUST VALVE GASKET, LEFT SIDE

K S J



P025000005548 | 12108-KZ4-620
EXHAUST VALVE GASKET, RIGHT SIDE

K S J



P025000005549 | 12112-KZ4-620
EXHAUST VALVE GASKET, UPPER

K S J

2 UNITS

ARTEIN PART No.	DESCRIPTION	UNITS	TOP END KIT K0000HN0K0852	SMART KIT S0000HN0S0852	COMPLETE SET J0000HN000852	ORIGINAL PART No.
P001000005368	CYLINDER HEAD GASKET	1	▪	▪	▪	12251-KZ4-A91
P02E000005366	CYLINDER BASE GASKET '00 (0,3 MM)	1	▪	▪	▪	-
P02F000005366	CYLINDER BASE GASKET '00 (0,4 MM)	1	▪	▪	▪	-
P02G000005366	CYLINDER BASE GASKET '00 (0,5 MM)	1	▪	▪	▪	12191-KZ4-A90
P02E000005367	CYLINDER BASE GASKET '01-'02 (0,3 MM)	1	▪	▪	▪	-
P02F000005367	CYLINDER BASE GASKET '01-'02 (0,4 MM)	1	▪	▪	▪	-
P02G000005367	CYLINDER BASE GASKET '01-'02 (0,5 MM)	1	▪	▪	▪	12191-KZ4-L10
P012000005372	EXHAUST GASKET	1	▪	▪	▪	18291-KZ4-700
P025000005370	EXHAUST VALVE COVER GASKET, RIGHT SIDE	1	▪	▪	▪	12108-KZ4-A90
P015000005369	REED VALVE GASKET	1	▪	▪	▪	14132-KZ4-620
X520001900300	O-RING (WATER HOSE SEAL)	1	▪	▪	▪	91312-KE7-003
P018000005376	CLUTCH COVER GASKET	1	▪	▪	▪	11394-KZ4-A90
X520015150178	O-RING (FRICTION DISC COVER GASKET)	1	▪	▪	▪	91311-KS6-700
A801012018150	WASHER (OIL DRAIN)	1	▪	▪	▪	94109-12000
A801006012150	WASHER (CYLINDER / CLUTCH COVER / WATER PUMP)	4	▪	▪	▪	90430-PD6-003
P014000005375	WATER PUMP COVER GASKET	2	▪	▪	▪	19229-KZ4-620
P003000005373	CRANKCASE GASKET	1	▪	▪	▪	11191-KZ4-A90
P016000005378	IGNITION COVER GASKET	1	▪	▪	▪	11352-KS6-700
X520002000150	O-RING (FRONT SPROCKET)	1	▪	▪	▪	91351-KA3-711
X520001580240	O-RING (OIL FILLER CAP)	1	▪	▪	▪	91304-MJ0-003
X520001800300	O-RING (OIL FILLER CAP)	1	▪	▪	▪	91307-035-000

XRADICAL
SUPER GASKETS



P02E000005366 (0,3 mm)
P02F000005366 (0,4 mm)
P02G000005366 (0,5 mm) | 12191-KZ4-A90 K S J
CYLINDER BASE GASKET (2000)



P02E000005367 (0,3 mm)
P02F000005367 (0,4 mm)
P02G000005367 (0,5 mm) | 12191-KZ4-L10 K S J
CYLINDER BASE GASKET (2001-2002)

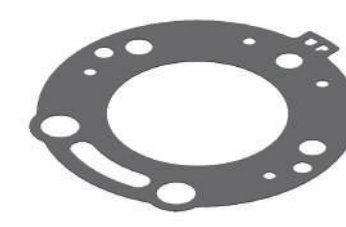

P001000005368 | 12251-KZ4-A91 K S J
CYLINDER HEAD GASKET



P012000005372 | 18291-KZ4-700 K S J
EXHAUST GASKET



P003000005373 | 11191-KZ4-A90 J
CRANKCASE GASKET

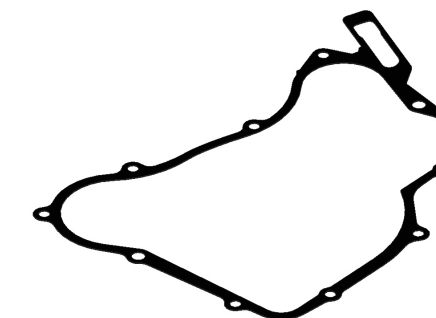

P018000005376 | 11394-KZ4-A90 S J
CLUTCH COVER GASKET



P016000005378 | 11352-KS6-700 J
IGNITION COVER GASKET

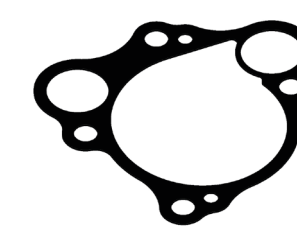

P014000005375 | 19229-KZ4-620 S J
WATER PUMP COVER GASKET 2 UNITS



P025000005370 | 12108-KZ4-A90 K S J
EXHAUST VALVE COVER GASKET, RIGHT SIDE

ARTEIN PART No.	DESCRIPTION	UNITS	TOP END KIT K0000HN0K0853	SMART KIT S0000HN0S0853	COMPLETE SET J0000HN000853	ORIGINAL PART No.
P001000005368	CYLINDER HEAD GASKET	1	▪	▪	▪	12251-KZ4-A91
P02E000005379	CYLINDER BASE GASKET (0,3 MM)	1	▪	▪	▪	-
P02F000005379	CYLINDER BASE GASKET (0,4 MM)	1	▪	▪	▪	-
P02G000005379	CYLINDER BASE GASKET (0,5 MM)	1	▪	▪	▪	12191-KZ4-L30
P012000005372	EXHAUST GASKET	1	▪	▪	▪	18291-KZ4-700
P025000005370	EXHAUST VALVE COVER GASKET, RIGHT SIDE	1	▪	▪	▪	12108-KZ4-A90
P015000005380	REED VALVE GASKET	1	▪	▪	▪	14132-KZ4-L30
X520001900300	O-RING (WATER HOSE SEAL)	1	▪	▪	▪	91312-KE7-003
P018000005376	CLUTCH COVER GASKET	1	▪	▪	▪	11394-KZ4-A90
X520015150178	O-RING (FRICTION DISC COVER GASKET)	1	▪	▪	▪	91311-KS6-700
A801012018150	WASHER (OIL DRAIN)	1	▪	▪	▪	94109-12000
A801006012150	WASHER (CYLINDER/CLUTCH COVER/WATER PUMP)	4	▪	▪	▪	90430-PD6-003
P014000005375	WATER PUMP COVER GASKET	2	▪	▪	▪	19229-KZ4-620
P003000005382	CRANKCASE GASKET	1	▪	▪	▪	11191-KZ4-L30
P016000005383	IGNITION COVER GASKET	1	▪	▪	▪	11352-KZ4-L10
X520002000150	O-RING (FRONT SPROCKET)	1	▪	▪	▪	91351-KA3-711
X520001800300	O-RING (OIL FILLER CAP)	1	▪	▪	▪	91307-035-000

XRADICAL
SUPER GASKETS



P02E000005379 (0,3 mm)
P02F000005379 (0,4 mm)
P02G000005379 (0,5 mm) 12191-KZ4-L30 **K S J**
CYLINDER BASE GASKET



P001000005368 | 12251-KZ4-A91 **K S J**
CYLINDER HEAD GASKET



P012000005372 | 18291-KZ4-700 **K S J**
EXHAUST GASKET



P003000005382 | 11191-KZ4-L30 **J**
CRANKCASE GASKET

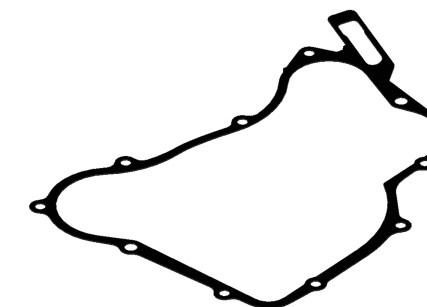

P018000005376 | 11394-KZ4-A90 **S J**
CLUTCH COVER GASKET



P016000005383 | 11352-KZ4-L10 **J**
IGNITION COVER GASKET

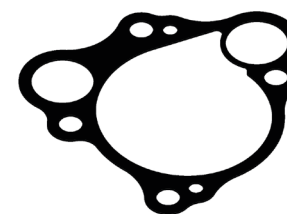

P014000005375 | 19229-KZ4-620 **S J**
WATER PUMP COVER GASKET **2 UNITS**



P025000005370 | 12108-KZ4-A90 **K S J**
EXHAUST VALVE COVER GASKET, RIGHT SIDE

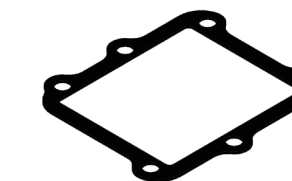

P015000005380 | 14132-KZ4-L30 **K S J**
REED VALVE GASKET

ARTEIN PART No.	DESCRIPTION	UNITS	TOP END KIT K0000HN0K0854	SMART KIT S0000HN0S0854	COMPLETE SET J0000HN000854	ORIGINAL PART No.
P001000005368	CYLINDER HEAD GASKET	1	▪	▪	▪	12251-KSR-A01
P02E000005384	CYLINDER BASE GASKET (0,3 MM)	1	▪	▪	▪	-
P02F000005384	CYLINDER BASE GASKET (0,4 MM)	1	▪	▪	▪	-
P02G000005384	CYLINDER BASE GASKET (0,5 MM)	1	▪	▪	▪	12191-KSR-A00
P012000005372	EXHAUST GASKET	1	▪	▪	▪	18291-KZ4-700
P025000005388	EXHAUST VALVE COVER GASKET, LEFT SIDE	1	▪	▪	▪	12111-KZ3-L20
P025000005387	EXHAUST VALVE COVER GASKET, RIGHT SIDE	1	▪	▪	▪	12108-KSR-A00
P015000005386	REED VALVE GASKET	1	▪	▪	▪	14132-KSR-A00
X520001900300	O-RING (WATER HOSE SEAL)	1	▪	▪	▪	91312-KE7-003
P018000005376	CLUTCH COVER GASKET	1	▪	▪	▪	11394-KZ4-A90
X520015150178	O-RING (FRICTION DISC COVER GASKET)	1	▪	▪	▪	91311-KS6-700
A801012018150	WASHER (OIL DRAIN)	1	▪	▪	▪	94109-12000
A801006012150	WASHER (CYLINDER/CLUTCH COVER/WATER PUMP)	4	▪	▪	▪	90430-PD6-003
P014000005375	WATER PUMP COVER GASKET	2	▪	▪	▪	19229-KZ4-620
P003000005382	CRANKCASE GASKET	1	▪	▪	▪	11191-KZ4-L30
P016000005383	IGNITION COVER GASKET	1	▪	▪	▪	11352-KZ4-L10
X520002000150	O-RING (FRONT SPROCKET)	1	▪	▪	▪	91351-KA3-711
X520001800300	O-RING (OIL FILLER CAP)	1	▪	▪	▪	91307-035-000

XRADICAL
SUPER GASKETS



P02E000005384 (0,3 mm)
P02F000005384 (0,4 mm)
P02G000005384 (0,5 mm) | 12191-KSR-A00 **K S J**

CYLINDER BASE GASKET



P001000005368 | 12251-KSR-A01 **K S J**

CYLINDER HEAD GASKET



P012000005372 | 18291-KZ4-700 **K S J**

EXHAUST GASKET

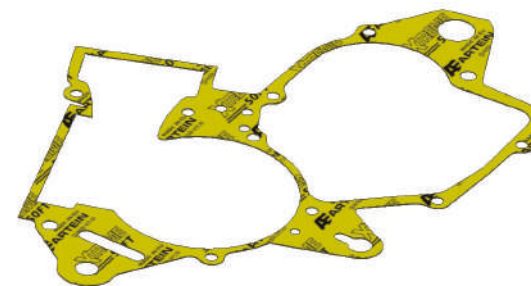

P003000005382 | 11191-KZ4-L30 **J**

CRANKCASE GASKET

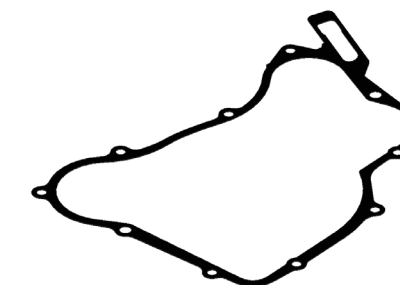

P018000005376 | 11394-KZ4-A90 **S J**

CLUTCH COVER GASKET

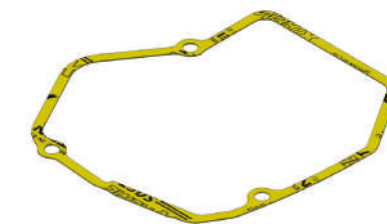

P016000005383 | 11352-KZ4-L10 **J**

IGNITION COVER GASKET

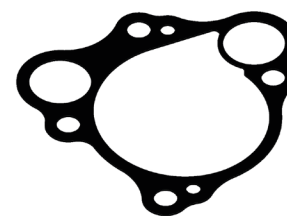

P014000005375 | 19229-KZ4-620 **S J**

WATER PUMP COVER GASKET

2 UNITS

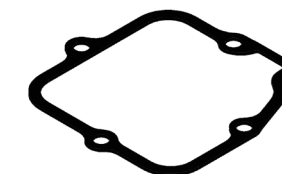

P025000005387 | 12108-KSR-A00 **K S J**

EXHAUST VALVE COVER GASKET, RIGHT SIDE



P025000005388 | 12111-KZ3-L20 **K S J**

EXHAUST VALVE COVER GASKET, LEFT SIDE

ARTEIN PART No.	DESCRIPTION	UNITS	TOP END KIT K0000HN0K0855	SMART KIT S0000HN0S0855	COMPLETE SET J0000HN000855	ORIGINAL PART No.
P001000005390	CYLINDER HEAD GASKET	1	▪	▪	▪	12251-KSR-731
P02D000005389	CYLINDER BASE GASKET	1	▪	▪	▪	12191-KSR-731
P012000005393	EXHAUST GASKET	1	▪	▪	▪	18291-KSR-730
P025000005392	EXHAUST VALVE COVER GASKET, LEFT SIDE	1	▪	▪	▪	12111-KSR-730
P025000005370	EXHAUST VALVE COVER GASKET, RIGHT SIDE	1	▪	▪	▪	12108-KZ4-A90
P015000005391	REED VALVE GASKET	1	▪	▪	▪	14132-KSR-730
P018000005396	CLUTCH COVER GASKET	1	▪	▪	▪	11394-KSR-730
X520015150178	O-RING (FRICTION DISC COVER GASKET)	1	▪	▪	▪	91311-KS6-700
A801012018150	WASHER (OIL DRAIN)	1	▪	▪	▪	94109-12000
A801006012150	WASHER (CLUTCH COVER/WATER PUMP)	3	▪	▪	▪	90430-PD6-003
P014000005395	WATER PUMP COVER GASKET	1	▪	▪	▪	19229-KSR-730
P003000005394	CRANKCASE GASKET	1	▪	▪	▪	11191-KSR-730
P016000005397	IGNITION COVER GASKET	1	▪	▪	▪	11352-KXR-730
X520002000150	O-RING (FRONT SPROCKET)	1	▪	▪	▪	91351-KA3-711
X520001800300	O-RING (OIL FILLER CAP)	1	▪	▪	▪	91307-035-000



▲ P02D000005389 | 12191-KSR-731 **K S J**
CYLINDER BASE GASKET

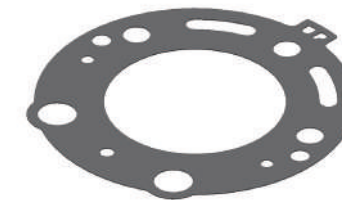

▲ P001000005390 | 12251-KSR-731 **K S J**
CYLINDER HEAD GASKET



▲ P012000005393 | 18291-KSR-730 **K S J**
EXHAUST GASKET

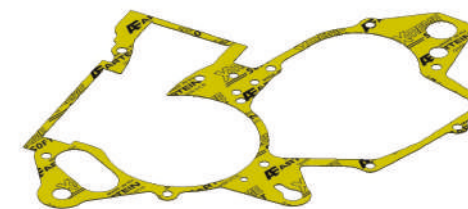

▲ P003000005394 | 11191-KSR-730 **J**
CRANKCASE GASKET

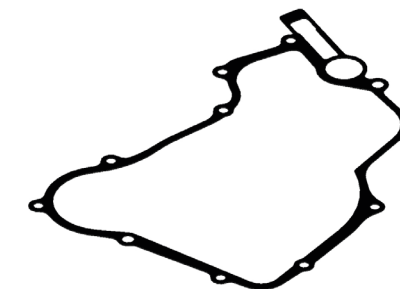

▲ P018000005396 | 11394-KSR-730 **S J**
CLUTCH COVER GASKET



▲ P016000005397 | 11352-KXR-730 **J**
IGNITION COVER GASKET



▲ P014000005395 | 19229-KSR-730 **S J**
WATER PUMP GASKET



▲ P025000005370 | 12108-KZ4-A90 **K S J**
EXHAUST VALVE COVER GASKET, RIGHT SIDE

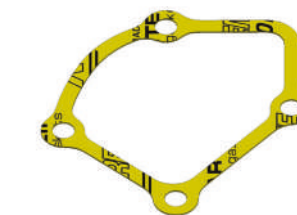

▲ P025000005392 | 12111-KSR-730 **K S J**
EXHAUST VALVE COVER GASKET, LEFT SIDE

ARTEIN PART No.	DESCRIPTION	UNITS	TOP END KIT K0000HN0K0856	SMART KIT S0000HN0S0856	COMPLETE SET J0000HN000856	ORIGINAL PART No.
P001000005399	CYLINDER HEAD GASKET	1	▪	▪	▪	12254-KZ3-860
P02E000005398	CYLINDER BASE GASKET (0,3 MM)	1	▪	▪	▪	-
P02F000005398	CYLINDER BASE GASKET (0,4 MM)	1	▪	▪	▪	-
P02G000005398	CYLINDER BASE GASKET (0,5 MM)	1	▪	▪	▪	12191-KZ3-880
P015000005402	REED VALVE GASKET	1	▪	▪	▪	14132-KZ3-880
X560004300300	O-RING (EXHAUST)	1	▪	▪	▪	91304-KZ3-890
P025000005401	EXHAUST VALVE COVER GASKET, RIGHT SIDE	1	▪	▪	▪	12108-KZ3-880
T520003100300	O-RING (EXHAUST VALVE)	1	▪	▪	▪	91302-001-020
P018000005406	CLUTCH COVER GASKET	1	▪	▪	▪	11395-KZ3-880
P025000005407	FRICTION DISC COVER GASKET (O-RING)	1	▪	▪	▪	91311-KS7-701
A801012018150	WASHER (OIL DRAIN)	1	▪	▪	▪	94109-12000
A820006012150	WASHER (CLUTCH COVER/WATER PUMP)	2	▪	▪	▪	90543-273-000
P014000005409	WATER PUMP COVER GASKET	2	▪	▪	▪	19229-KZ3-880
P003000005404	CRANKCASE GASKET ('92-'99)	1	▪	▪	▪	11191-KZ3-880
P003000005405	CRANKCASE GASKET ('00-'01)	1	▪	▪	▪	11191-KZ3-J20
P025000005403	CRANKCASE WATER HOSE SEAL (O-RING)	1	▪	▪	▪	91301-KZ3-861
P016000005408	IGNITION COVER GASKET	1	▪	▪	▪	11352-KA4-771
X520001800300	O-RING (OIL FILLER CAP)	1	▪	▪	▪	91307-035-000

XRADICAL
SUPER GASKETS



P02E000005398 (0,3 mm)
P02F000005398 (0,4 mm)
P02G000005398 (0,5 mm) | 12191-KZ3-880
K S J
CYLINDER BASE GASKET

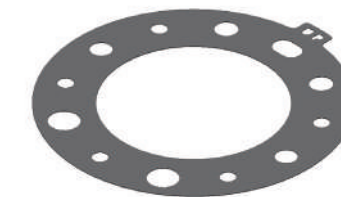

P001000005399 | 12254-KZ3-860
K S J
CYLINDER HEAD GASKET



P003000005404 | 11191-KZ3-880
J
CRANKCASE GASKET (1992-1999)



P003000005405 | 11191-KZ3-J20
J
CRANKCASE GASKET (2000-2001)

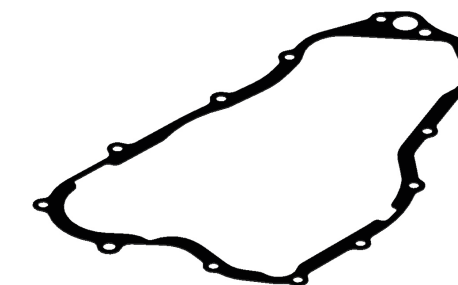

P018000005406 | 11395-KZ3-880
S J
CLUTCH COVER GASKET

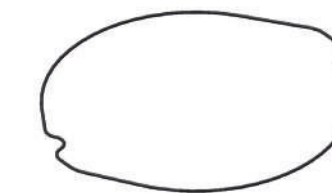

P025000005407 | 91311-KS7-701
S J
FRICTION DISC COVER GASKET (O-RING)



P016000005408 | 11352-KA4-771
J
IGNITION COVER GASKET

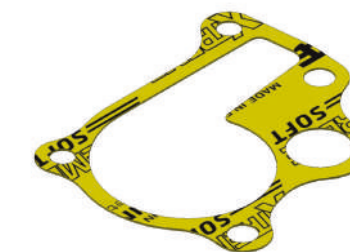

P014000005409 | 19229-KZ3-880
S J
WATER PUMP GASKET
2 UNITS

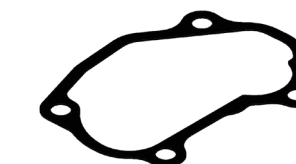

P025000005401 | 12108-KZ3-880
K S J
EXHAUST VALVE COVER GASKET, RIGHT SIDE

ARTEIN PART No.	DESCRIPTION	UNITS	TOP END KIT K0000HN0K0857	SMART KIT S0000HN0S0857	COMPLETE SET J0000HN000857	ORIGINAL PART No.
P001000005413	CYLINDER HEAD GASKET	1	▪	▪	▪	12254-KZ3-L21
P02E000005412	CYLINDER BASE GASKET (0,3 MM)	1	▪	▪	▪	-
P02F000005412	CYLINDER BASE GASKET (0,4 MM)	1	▪	▪	▪	-
P02G000005412	CYLINDER BASE GASKET (0,5 MM)	1	▪	▪	▪	12191-KZ3-L20
P012000005416	EXHAUST GASKET	1	▪	▪	▪	18291-KZ3-L20
P025000005388	EXHAUST VALVE COVER GASKET, LEFT SIDE	1	▪	▪	▪	12111-KZ3-L20
P015000005414	REED VALVE GASKET	1	▪	▪	▪	14132-KZ3-L20
P018000005420	CLUTCH COVER GASKET	1	▪	▪	▪	11395-KZ3-L20
P025000005421	FRICTION DISC COVER GASKET (O-RING)	1	▪	▪	▪	91311-KZ3-L21
A801012018150	WASHER (OIL DRAIN)	1	▪	▪	▪	94109-12000
A820006010150	WASHER (CLUTCH COVER/WATER PUMP)	2	▪	▪	▪	90543-273-000
P014000005419	WATER PUMP COVER GASKET	2	▪	▪	▪	19229-KZ3-L20
P003000005418	CRANKCASE GASKET	1	▪	▪	▪	11191-KZ3-L20
P016000005422	IGNITION COVER GASKET	1	▪	▪	▪	11352-KZ3-L20
P014000005423	CRANKCASE WATER HOSE SEAL (O-RING)	1	▪	▪	▪	91301-KZ3-L20
X520001800300	O-RING (OIL FILLER CAP)	1	▪	▪	▪	91307-035-000

XRADICAL
SUPER GASKETS



P02E000005412 (0,3 mm)
P02F000005412 (0,4 mm)
P02G000005412 12191-KZ3-L20 (0,5 mm) **K S J**

CYLINDER BASE GASKET

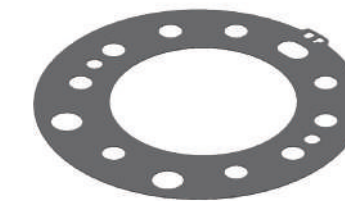

P001000005413 | 12254-KZ3-L21 **K S J**

CYLINDER HEAD GASKET



P012000005416 | 18291-KZ3-L20 **K S J**

EXHAUST GASKET



P003000005418 | 11191-KZ3-L20 **J**

CRANKCASE GASKET

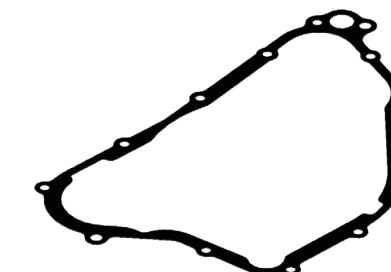

P018000005420 | 11395-KZ3-L20 **S J**

CLUTCH COVER GASKET

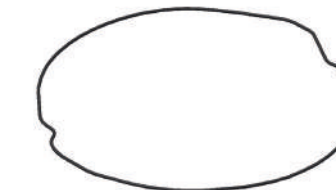

P025000005421 | 91311-KZ3-L21 **S J**

FRICTION DISC COVER GASKET



P016000005422 | 11352-KZ3-L20 **J**

IGNITION COVER GASKET



P014000005419 | 19229-KZ3-L20 **S J**

WATER PUMP GASKET

2 UNITS



P025000005388 | 12111-KZ3-L20 **K S J**

EXHAUST VALVE COVER GASKET, LEFT SIDE

ARTEIN PART No.	DESCRIPTION	UNITS	TOP END KIT K0000HN0K0858	SMART KIT S0000HN0S0858	COMPLETE SET J0000HN000858	ORIGINAL PART No.
P001000005413	CYLINDER HEAD GASKET ('04)	1	▪	▪	▪	12254-KZ3-L21
P001000005411	CYLINDER HEAD GASKET ('05-'07)	1	▪	▪	▪	12254-KSK-731
P02E000005412	CYLINDER BASE GASKET (0,3 MM)	1	▪	▪	▪	-
P02F000005412	CYLINDER BASE GASKET (0,4 MM)	1	▪	▪	▪	-
P02G000005412	CYLINDER BASE GASKET (0,5 MM)	1	▪	▪	▪	12191-KZ3-L20
P012000005425	EXHAUST GASKET	1	▪	▪	▪	18291-KSK-671
P025000005388	EXHAUST VALVE COVER GASKET, LEFT SIDE	1	▪	▪	▪	12111-KZ3-L20
X560004300300	O-RING (EXHAUST)	2	▪	▪	▪	91304-KZ3-890
X520001380190	O-RING (WATER HOSE SEAL)	4	▪	▪	▪	91302-KSK-731
A820008016150	WASHER (CYLINDER HEAD)	2	▪	▪	▪	90442-028-000
P015000005414	REED VALVE GASKET	1	▪	▪	▪	14132-KZ3-L20
P018000005420	CLUTCH COVER GASKET	1	▪	▪	▪	11395-KZ3-L20
P025000005421	FRICTION DISC COVER GASKET (O-RING)	1	▪	▪	▪	91311-KZ3-L21
A801012018150	WASHER (OIL DRAIN)	1	▪	▪	▪	94109-12000
A801006012150	WASHER (CLUTCH COVER/WATER PUMP)	2	▪	▪	▪	90430-PD6-003
P014000005419	WATER PUMP COVER GASKET	2	▪	▪	▪	19229-KZ3-L20
P003000005424	CRANKCASE GASKET	1	▪	▪	▪	11191-KSK-670
P016000005422	IGNITION COVER GASKET	1	▪	▪	▪	11352-KZ3-L20
P014000005423	CRANKCASE WATER HOSE SEAL (O-RING)	1	▪	▪	▪	91301-KZ3-L20
X520001800300	O-RING (OIL FILLER CAP)	1	▪	▪	▪	91307-035-000

XRADICAL
SUPER GASKETS



P02E000005412 (0,3 mm)
P02F000005412 (0,4 mm)
P02G000005412 12191-KZ3-L20 (0,5 mm) **K S J**
CYLINDER BASE GASKET

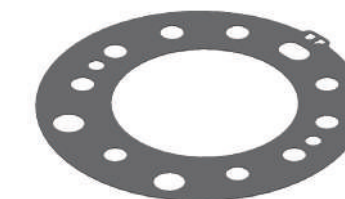

P001000005413 (2004) 12254-KZ3-L21
P001000005411 (2005-07) 12254-KSK-731 **K S J**
CYLINDER HEAD GASKET



P012000005425 18291-KSK-671 **K S J**
EXHAUST GASKET



P003000005424 11191-KSK-670 **J**
CRANKCASE GASKET

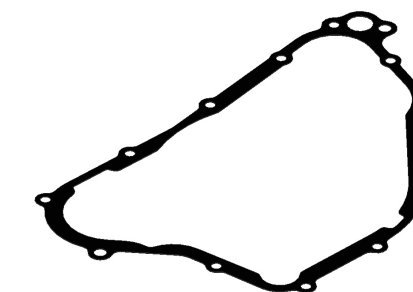

P018000005420 11395-KZ3-L20 **S J**
CLUTCH COVER GASKET

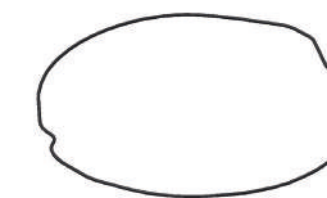

P025000005421 91311-KZ3-L21 **S J**
FRICTION DISC COVER GASKET (O-RING)



P016000005422 11352-KZ3-L20 **J**
IGNITION COVER GASKET



P014000005419 19229-KZ3-L20 **S J**
WATER PUMP GASKET **2 UNITS**



P025000005388 12111-KZ3-L20 **K S J**
EXHAUST VALVE COVER GASKET, LEFT SIDE

ARTEIN PART No.	DESCRIPTION	UNITS	TOP END KIT K0000HN0K0832	SMART KIT S0000HN0S0832	COMPLETE SET J0000HN000832	ORIGINAL PART No.
P001000005261	CYLINDER HEAD GASKET	1	▪	▪	▪	12251-KRN-731
P02F000005260	CYLINDER BASE GASKET	1	▪	▪	▪	12191-KRN-731
P012000XR5264	EXHAUST GASKET	1	▪	▪	▪	18291-MM5-860
P010000005262	DISTRIBUTION TENSIONER GASKET	1	▪	▪	▪	14560-MEN-671
KRV00HNOV0832	VALVE STEM SEALS KIT	1	▪	▪	▪	-
A801006014100	WASHER (DISTRIBUTION TENSIONER)	1	▪	▪	▪	90442-397-000
X520001400250	O-RING (CYLINDER HEAD)	1	▪	▪	▪	91303-MG7-003
P018000005265	CLUTCH COVER GASKET	1	▪	▪	▪	11394-KRN-A01
X520015150178	O-RING (FRICTION DISC COVER GASKET)	1	▪	▪	▪	11352-KRN-671
X520001580240	O-RING (WATER HOSE SEAL)	1	▪	▪	▪	91304-MJ0-003
X520002700200	O-RING (OIL DRAIN)	1	▪	▪	▪	91305-KF0-003
A801006012150	WASHER (OIL DRAIN/WATER PUMP)	2	▪	▪	▪	90430-PD6-003
X520001900300	O-RING (WATER HOSE SEAL)	1	▪	▪	▪	91312-KE7-003
P014000005263	WATER PUMP COVER GASKET	1	▪	▪	▪	19226-KRN-670
A801008014150	WASHER (OIL DRAIN)	1	▪	▪	▪	11191-KRN-670
P003000005259	CRANKCASE GASKET	1	▪	▪	▪	11395-KRN-671
P016000005267	IGNITION COVER GASKET	1	▪	▪	▪	91303-MG7-003
X520001400250	O-RING (IGNITION COVER)	1	▪	▪	▪	91302-PA9-003
X520003980220	O-RING (OIL FILTER)	1	▪	▪	▪	90751-GK1-003
X520000800180	O-RING (OIL PUMP)	1	▪	▪	▪	90474-333-000
X520001800300	O-RING (OIL FILLER CAP)	2	▪	▪	▪	91307-035-000
X520001200220	O-RING (OIL FILLER CAP)	1	▪	▪	▪	91370-461-000

RELATED PRODUCTS

ARTEIN PART No.	DESCRIPTION
KRV00HNOV0832	VALVE STEM SEALS KIT

XRADICAL
SUPER GASKETS



▲ P02F000005260 | 12191-KRN-731 **K S J**
CYLINDER BASE GASKET



▲ P001000005261 | 12251-KRN-731 **K S J**
CYLINDER HEAD GASKET



▲ P012000XR5264 | 18291-MM5-860 **K S J**
EXHAUST GASKET

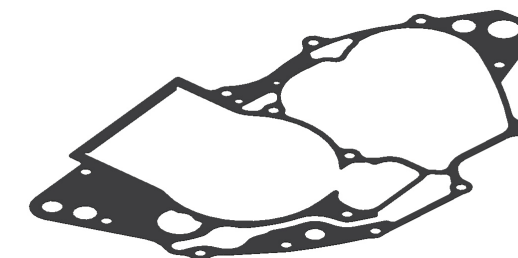

▲ P003000005259 | 11191-KRN-670 **J**
CRANKCASE GASKET

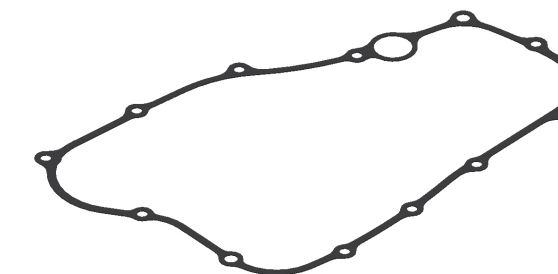

▲ P018000005265 | 11394-KRN-A01 **S J**
CLUTCH COVER GASKET

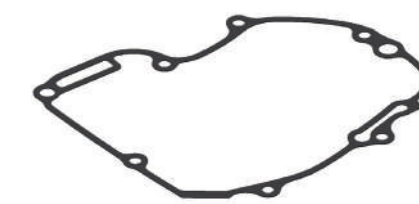

▲ P016000005267 | 11395-KRN-671 **J**
IGNITION COVER GASKET



▲ P014000005263 | 19226-KRN-670 **S J**
WATER PUMP COVER GASKET



▲ P010000005262 | 14560-MEN-671 **K S J**
DISTRIBUTION CHAIN TENSIONER GASKET

ARTEIN PART No.	DESCRIPTION	UNITS	TOP END KIT K0000HN0K0833	SMART KIT S0000HN0S0833	COMPLETE SET J0000HN000833	ORIGINAL PART No.
P001000005270	CYLINDER HEAD GASKET	1	▪	▪	▪	12251-KRN-A41
P02F000005269	CYLINDER BASE GASKET	1	▪	▪	▪	12191-KRN-A41
P012000XR5264	EXHAUST GASKET	1	▪	▪	▪	18291-MM5-860
P010000005262	DISTRIBUTION TENSIONER GASKET	1	▪	▪	▪	14560-MEN-671
A801006014100	WASHER (DISTRIBUTION TENSIONER)	1	▪	▪	▪	90442-397-000
KRV00HNOV0833	VALVE STEM SEALS KIT	1	▪	▪	▪	-
P018000005272	CLUTCH COVER GASKET	1	▪	▪	▪	11394-KRN-A40
X520017050178	O-RING (FRICTION DISC COVER GASKET)	1	▪	▪	▪	11352-KRN-A41
A801008014150	WASHER (OIL DRAIN)	1	▪	▪	▪	90474-333-000
P014000005271	WATER PUMP COVER GASKET	1	▪	▪	▪	19226-KRN-A40
A801006012150	WASHER (OIL DRAIN/WATER PUMP)	2	▪	▪	▪	90430-PD6-003
X520002700200	O-RING (OIL DRAIN)	1	▪	▪	▪	91305-KF0-003
P003000005268	CRANKCASE GASKET	1	▪	▪	▪	11191-KRN-A40
P016000005274	IGNITION COVER GASKET	1	▪	▪	▪	11395-KRN-A40
X520001400250	O-RING (OIL DRAIN)	2	▪	▪	▪	91303-MG7-003
X520003980220	O-RING (OIL FILTER)	1	▪	▪	▪	91302-PA9-003
X520000800180	O-RING (OIL FILTER)	1	▪	▪	▪	90751-GK1-003
X520001580240	O-RING (WATER HOSE SEAL)	1	▪	▪	▪	91304-MJ0-003
X520001900300	O-RING (WATER HOSE SEAL)	1	▪	▪	▪	91312-KE7-003
X520001800300	O-RING (OIL FILLER CAP)	1	▪	▪	▪	91307-035-000

RELATED PRODUCTS

ARTEIN PART No.	DESCRIPTION
KRV00HNOV0833	VALVE STEM SEALS KIT

XRADICAL
SUPER GASKETS



▲ P02F000005269 | 12191-KRN-A41 **K S J**
CYLINDER BASE GASKET



▲ P001000005270 | 12251-KRN-A41 **K S J**
CYLINDER HEAD GASKET



▲ P012000XR5264 | 18291-MM5-860 **K S J**
EXHAUST GASKET

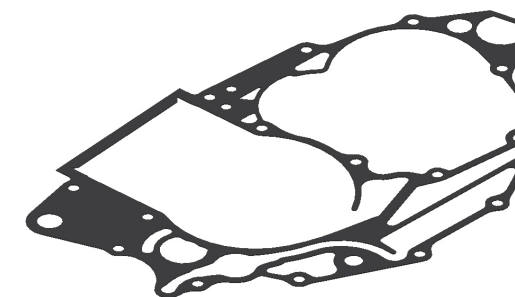

▲ P003000005268 | 11191-KRN-A40 **J**
CRANKCASE GASKET

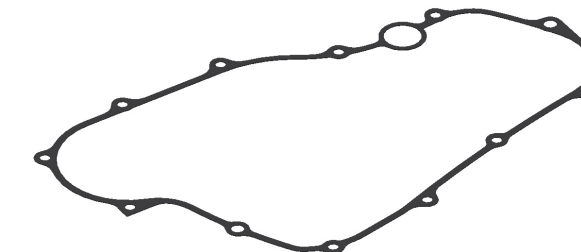

▲ P018000005272 | 11394-KRN-A40 **S J**
CLUTCH COVER GASKET

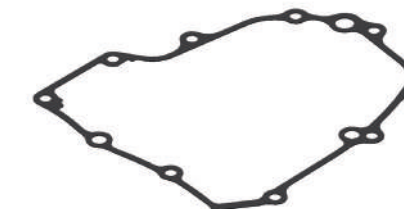

▲ P016000005274 | 11395-KRN-A40 **J**
IGNITION COVER GASKET



▲ P014000005271 | 19226-KRN-A40 **S J**
WATER PUMP COVER GASKET



▲ P010000005262 | 14560-MEN-671 **K S J**
DISTRIBUTION CHAIN TENSIONER GASKET

ARTEIN PART No.	DESCRIPTION	UNITS	TOP END KIT K0000HN0K0873	SMART KIT S0000HN0S0873	COMPLETE SET J0000HN000873	ORIGINAL PART No.
P001000005580	CYLINDER HEAD GASKET	1	▪	▪	▪	12251-K95-A21
P02F000005581	CYLINDER BASE GASKET	1	▪	▪	▪	12191-K95-A21
P012000XR1267	EXHAUST GASKET	2	▪	▪	▪	18291-KSV-J01
KRV00HNOV0832	VALVE STEM SEALS KIT	1	▪	▪	▪	-
P010000005582	DISTRIBUTION TENSIONER GASKET	1	▪	▪	▪	14523-K95-A21
A801006014100	WASHER (DISTRIBUTION CHAIN TENSIONER)	1	▪	▪	▪	90442-397-000
A820008014150	WASHER (CYLINDER HEAD)	1	▪	▪	▪	90544-439-930
X560002900200	O-RING (CAMSHAFT HOLDER)	1	▪	▪	▪	91301-K95-A21
A801006012150	WASHER (CYLINDER)	1	▪	▪	▪	90430-PD6-003
P018000005584	CLUTCH COVER GASKET	1	▪	▪	▪	11394-K95-A21
X520015800178	O-RING (FRICTION DISC COVER GASKET)	1	▪	▪	▪	11352-K95-A20
A801006012150	WASHER (CLUTCH COVER/WATER PUMP)	2	▪	▪	▪	90430-PD6-003
A820014020150	WASHER (OIL DRAIN)	1	▪	▪	▪	90544-KF0-000
P014000005587	WATER PUMP GASKET	1	▪	▪	▪	19226-K95-A20
X520001900300	O-RING (WATER HOSE SEAL)	1	▪	▪	▪	91312-KE7-003
X520000950190	O-RING (CLUTCH COVER/OIL PUMP)	3	▪	▪	▪	91305-PE2-003
P003000005583	CRANKCASE GASKET	1	▪	▪	▪	11191-K95-A21
P016000005585	IGNITION COVER GASKET	1	▪	▪	▪	11395-K95-A21
P013000005586	OIL PUMP GASKET	1	▪	▪	▪	15351-K95-A21
X520003980220	O-RING (OIL FILTER)	1	▪	▪	▪	91302-PA9-003
X560000800200	O-RING (FUEL INJECTOR)	1	▪	▪	▪	91301-P7A-004
X520000800180	O-RING (OIL PUMP)	1	▪	▪	▪	90751-GK1-003
X520001400250	O-RING (OIL DRAIN)	1	▪	▪	▪	91303-MG7-003
X520003160240	O-RING (IGNITION COVER)	1	▪	▪	▪	91305-KRM-840
X520001650250	O-RING (GEAR SWITCH SENSOR)	1	▪	▪	▪	91305-KC1-850
X520001400300	O-RING (OIL FILLER CAP)	1	▪	▪	▪	91307-KRN-A41

RELATED PRODUCTS

ARTEIN PART No.	DESCRIPTION
KRV00HNOV0832	VALVE STEM SEALS KIT

XRADICAL
SUPER GASKETS



▲ P001000005580 | 12251-K95-A21 **K S J**
CYLINDER HEAD GASKET



▲ P02F000005581 | 12191-K95-A21 **K S J**
CYLINDER BASE GASKET



▲ P010000005582 | 14523-K95-A21 **K S J**
DISTRIBUTION TENSIONER GASKET

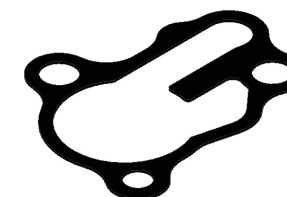

▲ P013000005586 | 15351-K95-A21 **J**
OIL PUMP GASKET

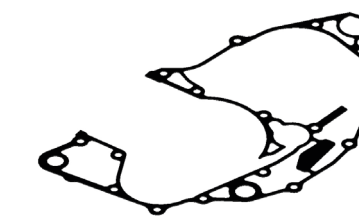

▲ P003000005583 | 11191-K95-A21 **J**
CRANKCASE GASKET

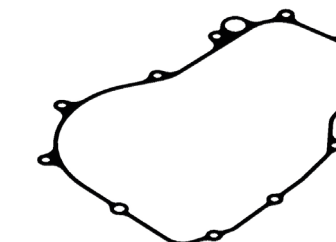

▲ P018000005584 | 11394-K95-A21 **S J**
CLUTCH COVER GASKET

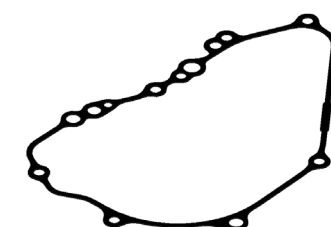

▲ P016000005585 | 11395-K95-A21 **J**
IGNITION COVER GASKET



▲ P014000005587 | 19226-K95-A20 **S J**
WATER PUMP GASKET

ARTEIN PART No.	DESCRIPTION	UNITS	TOP END KIT K0000HN0K0874	SMART KIT S0000HN0S0874	COMPLETE SET J0000HN000874	ORIGINAL PART No.
P001000005580	CYLINDER HEAD GASKET	1	▪	▪	▪	12251-K95-A21
P02F000005588	CYLINDER BASE GASKET	1	▪	▪	▪	12191-K95-AA1
P012000XR5264	EXHAUST GASKET	1	▪	▪	▪	18291-MM5-860
KRV00HNOV0837	VALVE STEM SEALS KIT	1	▪	▪	▪	-
P010000005582	DISTRIBUTION TENSIONER GASKET	1	▪	▪	▪	14523-K95-A21
A801006014100	WASHER (DISTRIBUTION CHAIN TENSIONER)	1	▪	▪	▪	90442-397-000
A820010016150	WASHER (CYLINDER HEAD)	3	▪	▪	▪	90443-MB0-000
X560002900200	O-RING (CAMSHAFT HOLDER)	1	▪	▪	▪	12395-MKR-D10
A801006012150	WASHER (CYLINDER/CYLINDER HEAD)	3	▪	▪	▪	90430-PD6-003
P018000005584	CLUTCH COVER GASKET	1	▪	▪	▪	11394-K95-A21
X520015800178	O-RING (FRICTION DISC COVER GASKET)	1	▪	▪	▪	11352-K95-A20
A801006012150	WASHER (CLUTCH COVER/WATER PUMP)	2	▪	▪	▪	90430-PD6-003
A820014020150	WASHER (OIL DRAIN)	1	▪	▪	▪	90544-KF0-000
P014000005587	WATER PUMP GASKET	1	▪	▪	▪	91302-PA9-003
X520001900300	O-RING (WATER HOSE SEAL)	1	▪	▪	▪	91312-KE7-003
X520000950190	O-RING (CLUTCH COVER/OIL PUMP)	3	▪	▪	▪	91305-PE2-003
P003000005583	CRANKCASE GASKET	1	▪	▪	▪	11191-K95-A21
P016000005585	IGNITION COVER GASKET	1	▪	▪	▪	11395-K95-A21
P013000005586	OIL PUMP GASKET	1	▪	▪	▪	15351-K95-A21
X520003980220	O-RING (OIL FILTER)	1	▪	▪	▪	19226-K95-A20
X560000800200	O-RING (FUEL INJECTOR)	1	▪	▪	▪	91301-P7A-004
X520000800180	O-RING (OIL PUMP)	1	▪	▪	▪	90751-GK1-003
X520001400250	O-RING (OIL DRAIN)	1	▪	▪	▪	91303-MG7-003
X520003160240	O-RING (IGNITION COVER)	1	▪	▪	▪	91305-KRM-840
X520001650250	O-RING (GEAR SWITCH SENSOR)	1	▪	▪	▪	91305-KC1-850
X520001400300	O-RING (OIL FILLER CAP)	1	▪	▪	▪	91307-KRN-A41

RELATED PRODUCTS

ARTEIN PART No.	DESCRIPTION
KRV00HNOV0837	VALVE STEM SEALS KIT

XRADICAL
SUPER GASKETS



▲ P001000005580 | 12251-K95-A21 **K S J**
CYLINDER HEAD GASKET



▲ P02F000005588 | 12191-K95-AA1 **K S J**
CYLINDER BASE GASKET



▲ P010000005582 | 14523-K95-A21 **K S J**
DISTRIBUTION TENSIONER GASKET

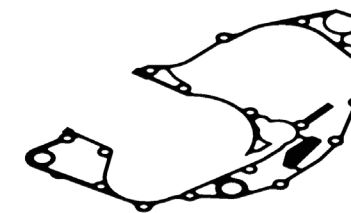

▲ P003000005583 | 11191-K95-A21 **J**
CRANKCASE GASKET

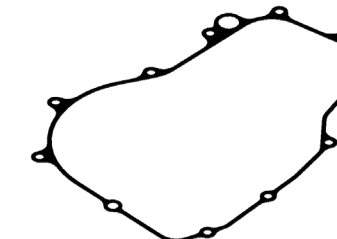

▲ P018000005584 | 11394-K95-A21 **S J**
CLUTCH COVER GASKET

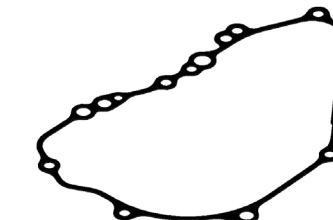

▲ P016000005585 | 11395-K95-A21 **J**
IGNITION COVER GASKET

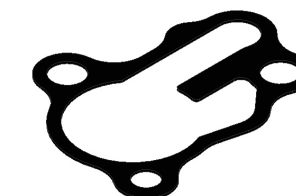

▲ P013000005586 | 15351-K95-A21 **J**
OIL PUMP GASKET



▲ P014000005587 | 19226-K95-A20 **S J**
WATER PUMP GASKET

ARTEIN PART No.	DESCRIPTION	UNITS	TOP END KIT K0000HN0K0834	SMART KIT S0000HN0S0834	COMPLETE SET J0000HN000834	ORIGINAL PART No.
P001000005276	CYLINDER HEAD GASKET	1	▪	▪	▪	12251-MEB-671
P02F000005275	CYLINDER BASE GASKET	1	▪	▪	▪	12191-MEB-671
P012000XR4282	EXHAUST GASKET	1	▪	▪	▪	18291-MEB-670
P010000005262	DISTRIBUTION TENSIONER GASKET	1	▪	▪	▪	14560-MEN-671
A801006014100	WASHER (DISTRIBUTION TENSIONER)	1	▪	▪	▪	90442-397-000
KRV00HNOV0834	VALVE STEM SEALS KIT	1	▪	▪	▪	-
P018000005281	CLUTCH COVER GASKET	1	▪	▪	▪	11394-MEB-670
X520016400178	O-RING (FRICTION DISC COVER GASKET)	1	▪	▪	▪	11352-MEB-671
X520001780240	O-RING (WATER HOSE SEAL)	1	▪	▪	▪	91256-383-721
A801006012150	WASHER (OIL DRAIN/WATER PUMP)	2	▪	▪	▪	90430-PD6-003
X520002700200	O-RING (OIL DRAIN)	1	▪	▪	▪	91305-KF0-003
P014000005280	WATER PUMP COVER GASKET	1	▪	▪	▪	19226-MEB-670
P003000005279	CRANKCASE GASKET	1	▪	▪	▪	11191-MEB-670
P016000005283	IGNITION COVER GASKET	1	▪	▪	▪	11395-MEB-670
X520003980220	O-RING (OIL FILTER)	1	▪	▪	▪	91302-PA9-003
X520000800180	O-RING (OIL FILTER)	1	▪	▪	▪	90751-GK1-003
X520001900300	O-RING (WATER HOSE SEAL)	1	▪	▪	▪	91312-KE7-003
X520001400250	O-RING (OIL DRAIN)	1	▪	▪	▪	91303-MG7-003
X520001800300	O-RING (OIL FILLER CAP)	2	▪	▪	▪	91307-035-000

RELATED PRODUCTS

ARTEIN PART No.	DESCRIPTION
KRV00HNOV0834	VALVE STEM SEALS KIT

XRADICAL
SUPER GASKETS



▲ P02F000005275 | 12191-MEB-671 **K S J**
CYLINDER BASE GASKET



▲ P001000005276 | 12251-MEB-671 **K S J**
CYLINDER HEAD GASKET



▲ P012000XR4282 | 18291-MEB-670 **K S J**
EXHAUST GASKET

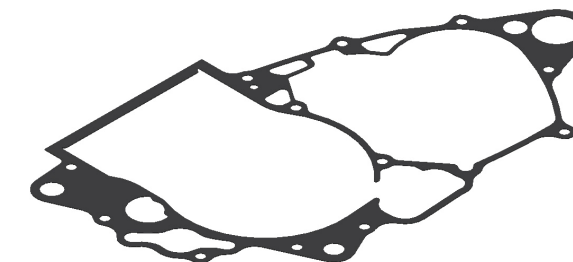

▲ P003000005279 | 11191-MEB-670 **J**
CRANKCASE GASKET

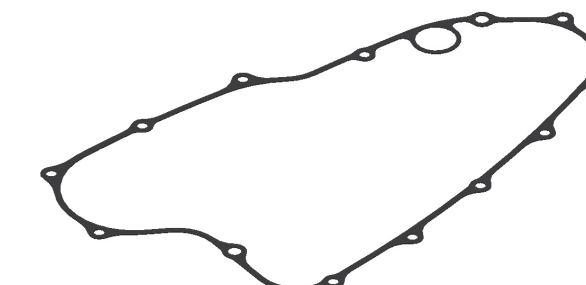

▲ P018000005281 | 11394-MEB-670 **S J**
CLUTCH COVER GASKET

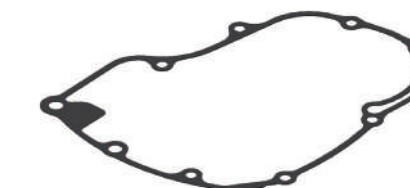

▲ P016000005283 | 11395-MEB-670 **J**
IGNITION COVER GASKET

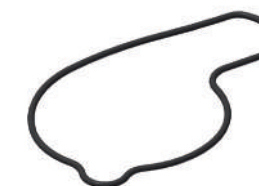

▲ P014000005280 | 19226-MEB-670 **S J**
WATER PUMP COVER GASKET



▲ P010000005262 | 14560-MEN-671 **K S J**
DISTRIBUTION CHAIN TENSIONER GASKET

ARTEIN PART No.	DESCRIPTION	UNITS	TOP END KIT K0000HN0K0835	SMART KIT S0000HN0S0835	COMPLETE SET J0000HN000835	ORIGINAL PART No.
P001000005276	CYLINDER HEAD GASKET	1	▪	▪	▪	12251-MEB-671
P02F000005275	CYLINDER BASE GASKET	1	▪	▪	▪	12191-MEB-671
P012000XR4282	EXHAUST GASKET	1	▪	▪	▪	18291-MEB-670
P010000005262	DISTRIBUTION TENSIONER GASKET	1	▪	▪	▪	14560-MEN-671
A801006014100	WASHER (DISTRIBUTION TENSIONER)	1	▪	▪	▪	90442-397-000
KRV00HNOV0834	VALVE STEM SEALS KIT	1	▪	▪	▪	-
P018000005281	CLUTCH COVER GASKET	1	▪	▪	▪	11394-MEB-670
X520016400178	O-RING (FRICTION DISC COVER GASKET)	1	▪	▪	▪	11352-MEB-671
X520001780240	O-RING (WATER HOSE SEAL)	1	▪	▪	▪	91256-383-721
A801006012150	WASHER (OIL DRAIN/WATER PUMP)	2	▪	▪	▪	90430-PD6-003
X520002700200	O-RING (OIL DRAIN)	1	▪	▪	▪	91305-KF0-003
P014000005280	WATER PUMP COVER GASKET	1	▪	▪	▪	19226-MEB-670
P003000005285	CRANKCASE GASKET	1	▪	▪	▪	11191-MEN-850
P016000005283	IGNITION COVER GASKET	1	▪	▪	▪	11395-MEB-670
X520003980220	O-RING (OIL FILTER)	1	▪	▪	▪	91302-PA9-003
X520000800180	O-RING (OIL FILTER)	1	▪	▪	▪	90751-GK1-003
X520001900300	O-RING (WATER HOSE SEAL)	1	▪	▪	▪	91312-KE7-003
X520001400250	O-RING (OIL DRAIN)	1	▪	▪	▪	91303-MG7-003
X520001800300	O-RING (OIL FILLER CAP)	2	▪	▪	▪	91307-035-000

RELATED PRODUCTS

ARTEIN PART No.	DESCRIPTION
KRV00HNOV0834	VALVE STEM SEALS KIT

XRADICAL
SUPER GASKETS



▲ P02F000005275 | 12191-MEB-671 **K S J**
CYLINDER BASE GASKET



▲ P001000005276 | 12251-MEB-671 **K S J**
CYLINDER HEAD GASKET



▲ P012000XR4282 | 18291-MEB-670 **K S J**
EXHAUST GASKET

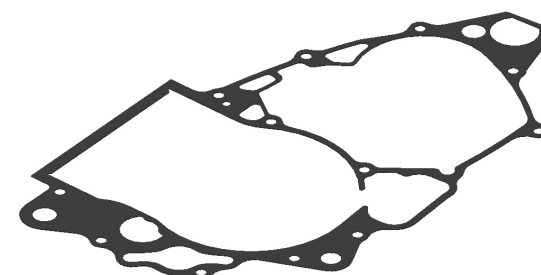

▲ P003000005285 | 11191-MEN-850 **J**
CRANKCASE GASKET

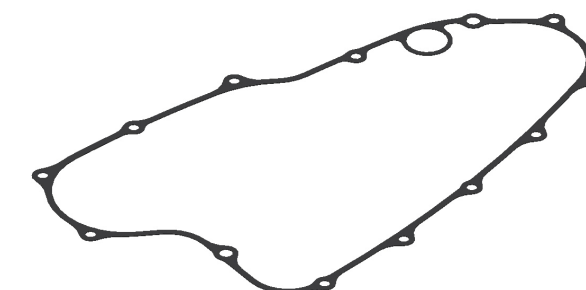

▲ P018000005281 | 11394-MEB-670 **S J**
CLUTCH COVER GASKET

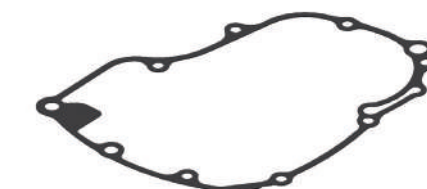

▲ P016000005283 | 11395-MEB-670 **J**
IGNITION COVER GASKET

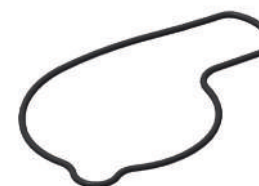

▲ P014000005280 | 19226-MEB-670 **S J**
WATER PUMP COVER GASKET



▲ P010000005262 | 14560-MEN-671 **K S J**
DISTRIBUTION CHAIN TENSIONER GASKET

ARTEIN PART No.	DESCRIPTION	UNITS	TOP END KIT K0000HN0K0836	SMART KIT S0000HN0S0836	COMPLETE SET J0000HN000836	ORIGINAL PART No.
P001000005286	CYLINDER HEAD GASKET	1	▪	▪	▪	12251-MEY-671
P02F000005275	CYLINDER BASE GASKET	1	▪	▪	▪	12191-MEB-671
P012000XR4282	EXHAUST GASKET	1	▪	▪	▪	18291-MEB-670
P010000005262	DISTRIBUTION TENSIONER GASKET	1	▪	▪	▪	14560-MEN-671
KRV00HNOV0834	VALVE STEM SEALS KIT	1	▪	▪	▪	-
P018000005281	CLUTCH COVER GASKET	1	▪	▪	▪	11394-MEB-670
X520016400178	O-RING (FRICTION DISC COVER GASKET)	1	▪	▪	▪	11352-MEB-671
X520001780240	O-RING (WATER HOSE SEAL)	1	▪	▪	▪	91256-383-721
A801006012150	WASHER (OIL DRAIN/WATER PUMP)	2	▪	▪	▪	90430-PD6-003
X520002700200	O-RING (OIL DRAIN)	1	▪	▪	▪	91305-KF0-003
P014000005280	WATER PUMP COVER GASKET	1	▪	▪	▪	19226-MEB-670
P003000005285	CRANKCASE GASKET	1	▪	▪	▪	11191-MEN-850
P016000005283	IGNITION COVER GASKET	1	▪	▪	▪	11395-MEB-670
X520003980220	O-RING (OIL FILTER)	1	▪	▪	▪	91302-PA9-003
X520001900300	O-RING (WATER HOSE SEAL)	1	▪	▪	▪	91312-KE7-003
X520001400250	O-RING (OIL DRAIN)	1	▪	▪	▪	91303-MG7-003
X520001800300	O-RING (OIL FILLER CAP)	2	▪	▪	▪	91307-035-000

RELATED PRODUCTS

ARTEIN PART No.	DESCRIPTION
KRV00HNOV0834	VALVE STEM SEALS KIT

XRADICAL
SUPER GASKETS



▲ P02F000005275 | 12191-MEB-671 **K S J**
CYLINDER BASE GASKET



▲ P001000005286 | 12251-MEY-671 **K S J**
CYLINDER HEAD GASKET



▲ P012000XR4282 | 18291-MEB-670 **K S J**
EXHAUST GASKET

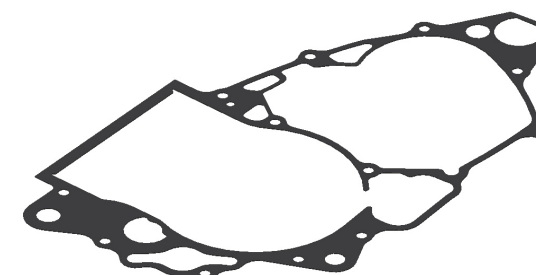

▲ P003000005285 | 11191-MEN-850 **J**
CRANKCASE GASKET

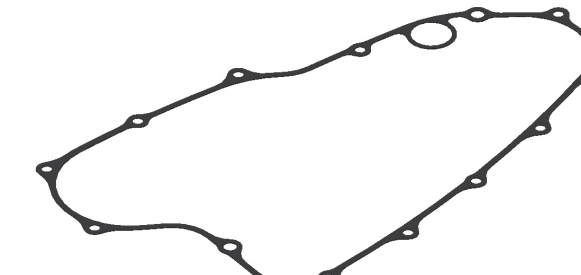

▲ P018000005281 | 11394-MEB-670 **S J**
CLUTCH COVER GASKET

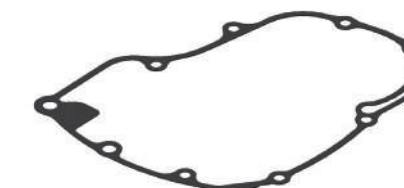

▲ P016000005283 | 11395-MEB-670 **J**
IGNITION COVER GASKET

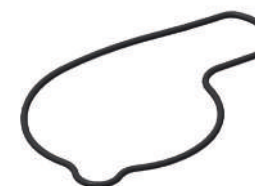

▲ P014000005280 | 19226-MEB-670 **S J**
WATER PUMP COVER GASKET



▲ P010000005262 | 14560-MEN-671 **K S J**
DISTRIBUTION CHAIN TENSIONER GASKET

ARTEIN PART No.	DESCRIPTION	UNITS	TOP END KIT K0000HN0K0837	SMART KIT S0000HN0S0837	COMPLETE SET J0000HN000837	ORIGINAL PART No.
P001000005288	CYLINDER HEAD GASKET	1	▪	▪	▪	12251-MEN-A31
P02F000005287	CYLINDER BASE GASKET	1	▪	▪	▪	12191-MEN-A31
P012000XR4282	EXHAUST GASKET	1	▪	▪	▪	18291-MEB-670
P010000005262	DISTRIBUTION TENSIONER GASKET	1	▪	▪	▪	14560-MEN-671
KRV00HNOV0837	VALVE STEM SEALS KIT	1	▪	▪	▪	-
P018000005294	CLUTCH COVER GASKET	1	▪	▪	▪	11394-MEN-A40
X520016400178	O-RING (FRICTION DISC COVER GASKET)	1	▪	▪	▪	11352-MEB-671
A801008014150	WASHER (OIL DRAIN)	1	▪	▪	▪	90474-333-000
X520002700200	O-RING (OIL DRAIN)	1	▪	▪	▪	91305-KF0-003
P014000005290	WATER PUMP COVER GASKET	1	▪	▪	▪	19226-MEN-A30
A801006012150	WASHER (OIL DRAIN/WATER PUMP)	2	▪	▪	▪	90430-PD6-003
P003000005293	CRANKCASE GASKET	1	▪	▪	▪	11191-MEN-A40
P016000005295	IGNITION COVER GASKET	1	▪	▪	▪	11395-MEN-A50
X520003980220	O-RING (OIL FILTER)	1	▪	▪	▪	91302-PA9-003
X520001900300	O-RING (WATER HOSE SEAL)	1	▪	▪	▪	91312-KE7-003
X520002180240	O-RING (WATER HOSE SEAL)	1	▪	▪	▪	91355-759-003
X520001400250	O-RING (OIL DRAIN)	1	▪	▪	▪	91303-MG7-003
X520001800300	O-RING (OIL FILLER CAP)	2	▪	▪	▪	91307-035-000

RELATED PRODUCTS

ARTEIN PART No.	DESCRIPTION
KRV00HNOV0837	VALVE STEM SEALS KIT

XRADICAL
SUPER GASKETS

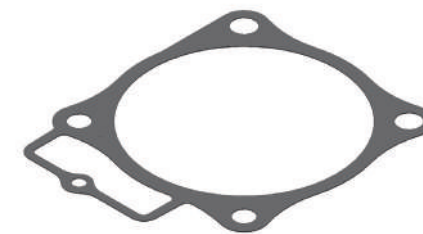

▲ P02F000005287 | 12191-MEN-A31 **K S J**
CYLINDER BASE GASKET



▲ P001000005288 | 12251-MEN-A31 **K S J**
CYLINDER HEAD GASKET



▲ P012000XR4282 | 18291-MEB-670 **K S J**
EXHAUST GASKET

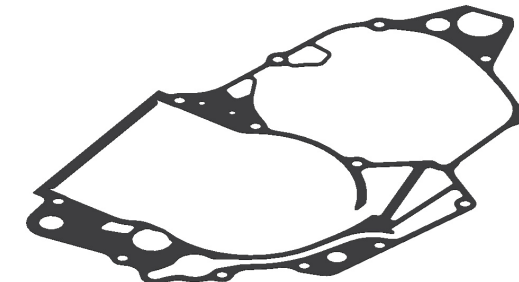

▲ P003000005293 | 11191-MEN-A40 **J**
CRANKCASE GASKET

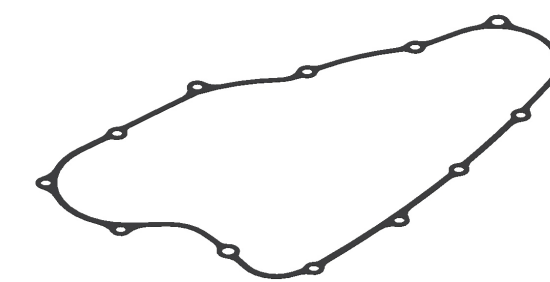

▲ P018000005294 | 11394-MEN-A40 **S J**
CLUTCH COVER GASKET



▲ P016000005295 | 11395-MEN-A50 **J**
IGNITION COVER GASKET



▲ P014000005290 | 19226-MEN-A30 **S J**
WATER PUMP COVER GASKET



▲ P010000005262 | 14560-MEN-671 **K S J**
DISTRIBUTION CHAIN TENSIONER GASKET

ARTEIN PART No.	DESCRIPTION	UNITS	TOP END KIT K0000HN0K0838	SMART KIT S0000HN0S0838	COMPLETE SET J0000HN000838	ORIGINAL PART No.
P001000005286	CYLINDER HEAD GASKET	1	▪	▪	▪	12251-MEY-671
P02F000005297	CYLINDER BASE GASKET	1	▪	▪	▪	12191-MEY-671
P012000XR4282	EXHAUST GASKET	1	▪	▪	▪	18291-MEB-670
P010000005262	DISTRIBUTION TENSIONER GASKET	1	▪	▪	▪	14560-MEN-671
KRV00HNOV0834	VALVE STEM SEALS KIT	1	▪	▪	▪	-
P018000005298	CLUTCH COVER GASKET	1	▪	▪	▪	11394-MEY-671
X520016400178	O-RING (FRICTION DISC COVER GASKET)	1	▪	▪	▪	11352-MEB-671
X520001780240	O-RING (WATER HOSE SEAL)	1	▪	▪	▪	91256-383-721
X520002180240	O-RING (WATER HOSE SEAL)	1	▪	▪	▪	91355-759-003
A801006012150	WASHER (OIL DRAIN/WATER PUMP)	2	▪	▪	▪	90430-PD6-003
X520002700200	O-RING (OIL DRAIN)	1	▪	▪	▪	91305-KF0-003
P014000005280	WATER PUMP COVER GASKET	1	▪	▪	▪	19226-MEB-670
P003000005296	CRANKCASE GASKET	1	▪	▪	▪	11191-MEY-671
P016000005299	IGNITION COVER GASKET	1	▪	▪	▪	11395-MEY-671
X520003980220	O-RING (OIL FILTER)	1	▪	▪	▪	91302-PA9-003
X520001900300	O-RING (WATER HOSE SEAL)	1	▪	▪	▪	91312-KE7-003
X520001400250	O-RING (OIL DRAIN)	1	▪	▪	▪	91303-MG7-003
X520001800300	O-RING (OIL FILLER CAP)	2	▪	▪	▪	91307-035-000

RELATED PRODUCTS

ARTEIN PART No.	DESCRIPTION
KRV00HNOV0834	VALVE STEM SEALS KIT

XRADICAL
SUPER GASKETS



▲ P02F000005297 | 12191-MEY-671 **K S J**
CYLINDER BASE GASKET



▲ P001000005286 | 12251-MEY-671 **K S J**
CYLINDER HEAD GASKET



▲ P012000XR4282 | 18291-MEB-670 **K S J**
EXHAUST GASKET

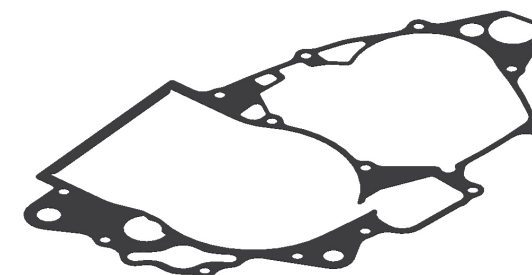

▲ P003000005296 | 11191-MEY-671 **J**
CRANKCASE GASKET

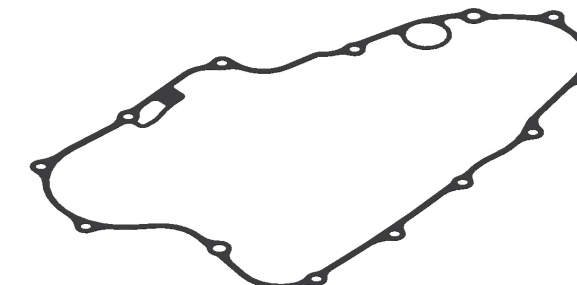

▲ P018000005298 | 11394-MEY-671 **S J**
CLUTCH COVER GASKET

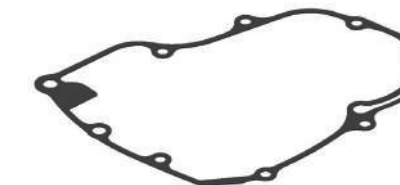

▲ P016000005299 | 11395-MEY-671 **J**
IGNITION COVER GASKET

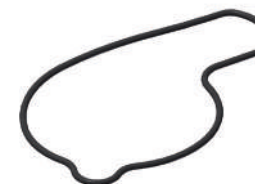

▲ P014000005280 | 19226-MEB-670 **S J**
WATER PUMP COVER GASKET



▲ P010000005262 | 14560-MEN-671 **K S J**
DISTRIBUTION CHAIN TENSIONER GASKET

ARTEIN PART No.	DESCRIPTION	UNITS	TOP END KIT K0000HN0K0883	SMART KIT S0000HN0S0883	COMPLETE SET J0000HN000883	ORIGINAL PART No.
P001000005636	CYLINDER HEAD GASKET	1	▪	▪	▪	12251-MKE-A01
P02F000005633	CYLINDER BASE GASKET	1	▪	▪	▪	12191-MKE-A01
P012000XR4282	EXHAUST GASKET	1	▪	▪	▪	18291-MEB-670
P010000005262	DISTRIBUTION TENSIONER GASKET	1	▪	▪	▪	14560-KCW-851
A801006014100	WASHER (DISTRIBUTION CHAIN TENSIONER)	1	▪	▪	▪	90442-397-000
KRV00HNOV0837	VALVE STEM SEALS KIT	1	▪	▪	▪	-
P014000005631	WATER PUMP GASKET	1	▪	▪	▪	19226-MKE-A00
P018000005632	CLUTCH COVER GASKET	1	▪	▪	▪	11394-MKE-A01
X520018000178	O-RING (FRICTION DISC)	1	▪	▪	▪	11352-MKE-A00
X520001900300	O-RING (WATER HOSE SEAL)	1	▪	▪	▪	91312-KE7-003
A801006012150	WASHER (CLUTCH COVER/WATER PUMP)	2	▪	▪	▪	90430-PD6-003
X560000780190	O-RING (FUEL INJECTOR)	1	▪	▪	▪	91301-P7A-004
X520003980220	O-RING (OIL FILTER)	1	▪	▪	▪	91302-PA9-003
X520000850170	O-RING (OIL FILTER)	2	▪	▪	▪	90751-GK1-003
X520001000200	O-RING (OIL PUMP)	1	▪	▪	▪	91305-PE2-003
P013000005637	OIL PUMP GASKET	1	▪	▪	▪	15351-MKE-A01
P003000005634	CRANKCASE GASKET	1	▪	▪	▪	11191-MKE-A01
P016000005635	IGNITION COVER GASKET	1	▪	▪	▪	11395-MKE-A01
X520002700200	O-RING (OIL DRAIN)	2	▪	▪	▪	91305-KF0-003
X520001900250	O-RING (CLUTCH COVER)	1	▪	▪	▪	91301-MKE-A00
X520001400300	O-RING (OIL FILLER CAP)	1	▪	▪	▪	91307-KRN-A41

RELATED PRODUCTS

ARTEIN PART No.	DESCRIPTION
KRV00HNOV0837	VALVE STEM SEALS KIT

XRADICAL
SUPER GASKETS



▲ P001000005636 | 12251-MKE-A01 **K S J**
CYLINDER HEAD GASKET



▲ P02F000005633 | 12191-MKE-A01 **K S J**
CYLINDER BASE GASKET



▲ P010000005262 | 14560-KCW-851 **K S J**
DISTRIBUTION TENSIONER GASKET

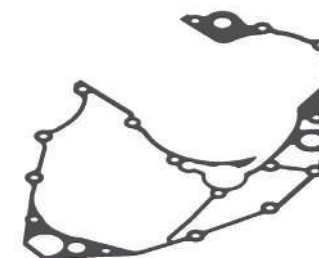

▲ P003000005634 | 11191-MKE-A01 **J**
CRANKCASE GASKET

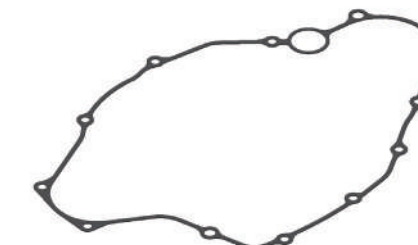

▲ P018000005632 | 11394-MKE-A01 **S J**
CLUTCH COVER GASKET

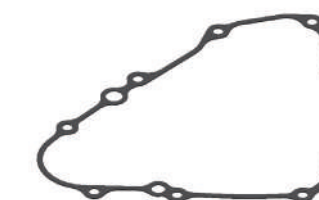

▲ P016000005635 | 11191-MKE-A01 **J**
IGNITION COVER GASKET

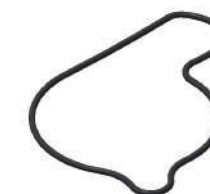

▲ P014000005631 | 19226-MKE-A00 **S J**
WATER PUMP GASKET



▲ P013000005637 | 15351-MKE-A01 **J**
OIL PUMP GASKET

ARTEIN PART No.	DESCRIPTION	UNITS	TOP END KIT K0000HN0K0884	SMART KIT S0000HN0S0884	COMPLETE SET J0000HN000884	ORIGINAL PART No.
P001000005640	CYLINDER HEAD GASKET	1	▪	▪	▪	12251-MKE-A71
P02F000005641	CYLINDER BASE GASKET	1	▪	▪	▪	12191-MKE-A71
P012000XR4282	EXHAUST GASKET	1	▪	▪	▪	18291-MEB-670
P010000005262	DISTRIBUTION TENSIONER GASKET	1	▪	▪	▪	14560-KCW-851
A801006014100	WASHER (DISTRIBUTION CHAIN TENSIONER)	1	▪	▪	▪	90442-397-000
KRV00HNOV0837	VALVE STEM SEALS KIT	1	▪	▪	▪	-
P014000005631	WATER PUMP GASKET	1	▪	▪	▪	19226-MKE-A00
P018000005639	CLUTCH COVER GASKET	1	▪	▪	▪	11394-MKE-A71
T520018100178	O-RING (FRICTION DISC)	1	▪	▪	▪	11352-MKE-A70
X520001900300	O-RING (WATER HOSE SEAL)	1	▪	▪	▪	91312-KE7-003
A801006012150	WASHER (CLUTCH COVER/WATER PUMP)	2	▪	▪	▪	90430-PD6-003
X560000780190	O-RING (FUEL INJECTOR)	1	▪	▪	▪	91301-P7A-004
X520003980220	O-RING (OIL FILTER)	1	▪	▪	▪	91302-PA9-003
X520000850170	O-RING (OIL FILTER)	2	▪	▪	▪	90751-GK1-003
X520001000200	O-RING (OIL PUMP)	1	▪	▪	▪	91305-PE2-003
P013000005637	OIL PUMP GASKET	1	▪	▪	▪	15351-MKE-A01
P003000005634	CRANKCASE GASKET	1	▪	▪	▪	11191-MKE-A01
P016000005635	IGNITION COVER GASKET	1	▪	▪	▪	11395-MKE-A01
X520002700200	O-RING (OIL DRAIN)	2	▪	▪	▪	91305-KF0-003
X520001900250	O-RING (CLUTCH COVER)	1	▪	▪	▪	91301-MKE-A00
X520002970240	O-RING (OIL DRAIN)	1	▪	▪	▪	91356-425-005
X520001650250	O-RING (GEAR SWITCH SENSOR)	1	▪	▪	▪	91305-KC1-850
X520001400300	O-RING (OIL FILLER CAP)	1	▪	▪	▪	91307-KRN-A41

RELATED PRODUCTS

ARTEIN PART No.	DESCRIPTION
KRV00HNOV0837	VALVE STEM SEALS KIT

XRADICAL
SUPER GASKETS



▲ P001000005640 | 12251-MKE-A71 **K S J**
CYLINDER HEAD GASKET



▲ P02F000005641 | 12191-MKE-A71 **K S J**
CYLINDER BASE GASKET



▲ P010000005262 | 14560-KCW-851 **K S J**
DISTRIBUTION TENSIONER GASKET

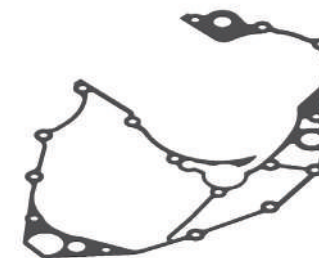

▲ P003000005634 | 11191-MKE-A01 **J**
CRANKCASE GASKET



▲ P018000005639 | 11394-MKE-A71 **S J**
CLUTCH COVER GASKET



▲ P016000005635 | 11191-MKE-A01 **J**
IGNITION COVER GASKET

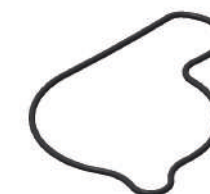

▲ P014000005631 | 19226-MKE-A00 **S J**
WATER PUMP GASKET



▲ P013000005637 | 15351-MKE-A01 **J**
OIL PUMP GASKET

ARTEIN PART No.	DESCRIPTION	UNITS	TOP END KIT K0000HN0K0885	SMART KIT S0000HN0S0885	COMPLETE SET J0000HN000885	ORIGINAL PART No.
P001000005642	CYLINDER HEAD GASKET	1	▪	▪	▪	12251-MKE-AF1
P02F000005641	CYLINDER BASE GASKET	1	▪	▪	▪	12191-MKE-A71
P012000XR5643	EXHAUST GASKET	1	▪	▪	▪	18291-MKE-AF0
P010000005262	DISTRIBUTION TENSIONER GASKET	1	▪	▪	▪	14560-MEN-671
A801006014100	WASHER (DISTRIBUTION CHAIN TENSIONER)	1	▪	▪	▪	90442-397-000
KRV00HNOV0837	VALVE STEM SEALS KIT	1	▪	▪	▪	-
P014000005631	WATER PUMP GASKET	1	▪	▪	▪	19226-MKE-A00
P018000005639	CLUTCH COVER GASKET	1	▪	▪	▪	11394-MKE-A71
T520018100178	O-RING (FRICTION DISC)	1	▪	▪	▪	11352-MKE-A70
X520001900300	O-RING (WATER HOSE SEAL)	1	▪	▪	▪	91312-KE7-003
A801006012150	WASHER (CLUTCH COVER/WATER PUMP)	2	▪	▪	▪	90430-PD6-003
X560000780190	O-RING (FUEL INJECTOR)	1	▪	▪	▪	91301-P7A-004
X520003980220	O-RING (OIL FILTER)	1	▪	▪	▪	91302-PA9-003
X520000850170	O-RING (OIL FILTER)	2	▪	▪	▪	90751-GK1-003
X520001000200	O-RING (OIL PUMP)	1	▪	▪	▪	91305-PE2-003
P013000005637	OIL PUMP GASKET	1	▪	▪	▪	15351-MKE-A01
P003000005634	CRANKCASE GASKET	1	▪	▪	▪	11191-MKE-A01
P016000005635	IGNITION COVER GASKET	1	▪	▪	▪	11395-MKE-A01
X520002700200	O-RING (OIL DRAIN)	2	▪	▪	▪	91305-KF0-003
X520001900250	O-RING (CLUTCH COVER)	1	▪	▪	▪	91301-MKE-A00
T520003160220	O-RING (OIL DRAIN)	1	▪	▪	▪	91356-KWV-000
P025000005277	CLUTCH SLAVE GASKET	1	▪	▪	▪	22867-MKE-AF0
T520002100250	O-RING (CLUTCH SLAVE)	2	▪	▪	▪	91301-MKE-AF1
X520001650250	O-RING (GEAR SWITCH SENSOR)	1	▪	▪	▪	91305-KC1-850
X520001400300	O-RING (OIL FILLER CAP)	1	▪	▪	▪	91307-KRN-A41

RELATED PRODUCTS

ARTEIN PART No.	DESCRIPTION
KRV00HNOV0837	VALVE STEM SEALS KIT

XRADICAL
SUPER GASKETS

▲ P001000005642 | 12251-MKE-AF1 **K S J**
CYLINDER HEAD GASKET



▲ P02F000005641 | 12191-MKE-A71 **K S J**
CYLINDER BASE GASKET



▲ P010000005262 | 14560-MEN-671 **K S J**
DISTRIBUTION TENSIONER GASKET



▲ P003000005634 | 11191-MKE-A01 **J**
CRANKCASE GASKET

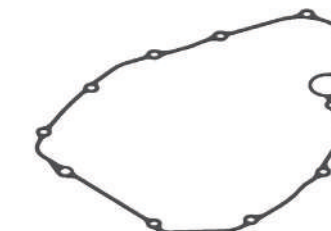

▲ P018000005639 | 11394-MKE-A71 **S J**
CLUTCH COVER GASKET



▲ P025000005277 | 22867-MKE-AF0 **J**
CLUTCH SLAVE GASKET

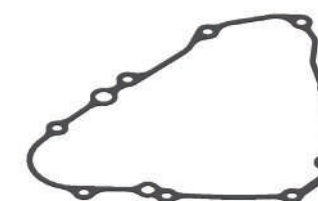

▲ P016000005635 | 11395-MKE-A01 **J**
IGNITION COVER GASKET

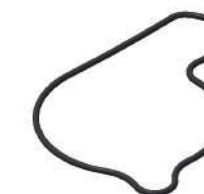

▲ P014000005631 | 19226-MKE-A00 **S J**
WATER PUMP GASKET



▲ P013000005637 | 15351-MKE-A01 **J**
OIL PUMP GASKET

ARTEIN PART No.	DESCRIPTION	UNITS	TOP END KIT K0000HU0K0868	SMART KIT S0000HU0S0868	COMPLETE SET J0000HU000868	ORIGINAL PART No.
X560006640178	O-RING (CYLINDER HEAD GASKET)	1	▪	▪	▪	800039630
X520009400200	O-RING (CYLINDER HEAD GASKET)	1	▪	▪	▪	800070635
P02E000005530	CYLINDER BASE GASKET (0,3 MM)	1	▪	▪	▪	800083068
P02F000005530	CYLINDER BASE GASKET (0,4 MM)	1	▪	▪	▪	8A0083068
P02G000005530	CYLINDER BASE GASKET (0,5 MM)	1	▪	▪	▪	8B0083068
P02I000005530	CYLINDER BASE GASKET (0,8 MM)	1	▪	▪	▪	8D0083068
A820008014200	WASHER (CYLINDER HEAD)	5	▪	▪	▪	800039335
X560003970353	O-RING (EXHAUST PIPE)	1	▪	▪	▪	8A0023186
X520002035178	O-RING (EXHAUST VALVE)	1	▪	▪	▪	800019789
X520005047262	O-RING (CENTRIFUGAL COVER)	1	▪	▪	▪	800028553
P015000005531	REED VALVE GASKET	1	▪	▪	▪	800083043
P025000005532	EXHAUST VALVE COVER GASKET, FRONT SIDE	1	▪	▪	▪	800083049
P025000005561	EXHAUST VALVE COVER GASKET, LEFT SIDE	1	▪	▪	▪	800083091
A801014022100	WASHER (OIL DRAIN)	1	▪	▪	▪	62N015678
A801006012100	WASHER (CLUTCH COVER)	1	▪	▪	▪	800003271
X520015200250	FRICTION DISC COVER GASKET	1	▪	▪	▪	800039694
P018000005534	CLUTCH COVER GASKET	1	▪	▪	▪	800066968
P014000005536	WATER PUMP COVER GASKET	1	▪	▪	▪	800065922
A820006010100	WASHER (WATER PUMP)	1	▪	▪	▪	800003271
P016000005535	IGNITION COVER GASKET	1	▪	▪	▪	800066972
P003000005533	CRANKCASE GASKET	1	▪	▪	▪	8000A8985
X520002035178	O-RING (FRONT SPROCKET)	1	▪	▪	▪	800019789
A820017025150	WASHER (OIL FILLER CAP)	1	▪	▪	▪	800027960



P02E000005530 | 800083068 (0,3 mm)
P02F000005530 | 8A0083068 (0,4 mm)
P02G000005530 | 8B0083068 (0,5 mm)
P02I000005530 | 8D0083068 (0,8 mm)

CYLINDER BASE GASKET

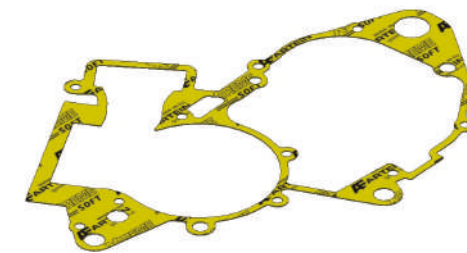

P003000005533 | 8000A8985

CRANKCASE GASKET

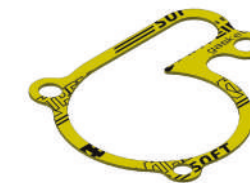

P014000005536 | 800065922

WATER PUMP COVER GASKET

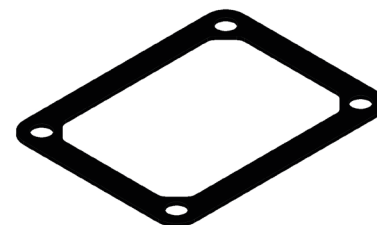

P015000005531 | 800083043

REED VALVE GASKET

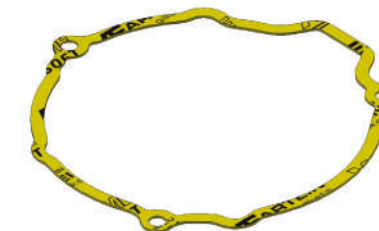

P016000005535 | 800066972

IGNITION COVER GASKET

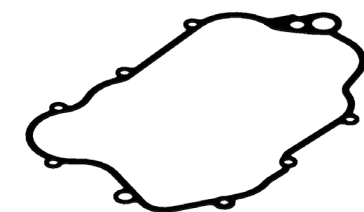

P018000005534 | 800066968

CLUTCH COVER GASKET



P025000005532 | 800083049

EXHAUST VALVE GASKET, FRONT SIDE



P025000005561 | 800083091

EXHAUST VALVE GASKET, LEFT SIDE

XRADICAL
SUPER GASKETS

ARTEIN PART No.	DESCRIPTION	UNITS	TOP END KIT K0000KW0K0817	SMART KIT S0000KW0S0817	COMPLETE SET J0000KW000817	ORIGINAL PART No.
P001000005173	CYLINDER HEAD GASKET	1	▪	▪	▪	11004-1346
P02D000005174	CYLINDER BASE GASKET (0,25 MM)	1	▪	▪	▪	-
P02E000005174	CYLINDER BASE GASKET (0,3 MM)	1	▪	▪	▪	-
P02F000005174	CYLINDER BASE GASKET (0,4 MM)	1	▪	▪	▪	11060-1921
P012000XR5175	EXHAUST GASKET	1	▪	▪	▪	11060-1922
X560003200350	O-RING (EXHAUST)	2	▪	▪	▪	670E3032
A801006511150	WASHER (CYLINDER HEAD)	1	▪	▪	▪	92022-304
P018000005177	CLUTCH COVER GASKET	1	▪	▪	▪	11061-0121
A801010016100	WASHER (OIL DRAIN)	1	▪	▪	▪	92065-058
A801006012100	WASHER (WATER PUMP)	1	▪	▪	▪	92022-077
P014000005179	WATER PUMP COVER GASKET ('00-'05)	1	▪	▪	▪	11060-1924
P014000005176	WATER PUMP COVER GASKET ('06->>)	1	▪	▪	▪	11061-0159
P014000005497	WATER PUMP ELBOW GASKET ('00-'05)	1	▪	▪	▪	11060-1927
P014000005498	WATER PUMP ELBOW GASKET ('06->>)	1	▪	▪	▪	11061-0202
P016000005180	IGNITION COVER GASKET ('00-'05)	1	▪	▪	▪	11009-1974
P016000005178	IGNITION COVER GASKET ('06->>)	1	▪	▪	▪	11061-0193
X560001750150	O-RING (FRONT SPROCKET)	2	▪	▪	▪	92055-022

XRADICAL SUPER GASKETS



P02D000005174 (0,25 mm)
P02E000005174 (0,3 mm)
P02F000005174 (0,4 mm) 11060-1921 **K S J**
CYLINDER BASE GASKET

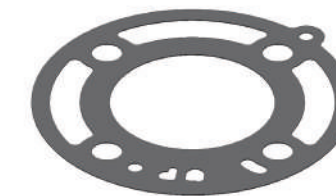

P001000005173 | 11004-1346 **K S J**
CYLINDER HEAD GASKET



P012000XR5175 | 11060-1922 **K S J**
EXHAUST GASKET

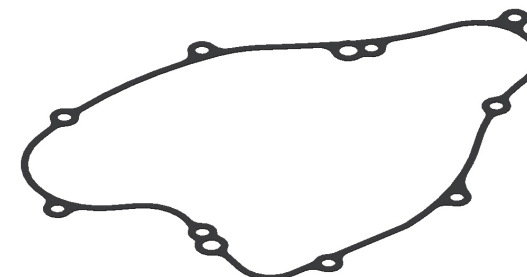

P018000005177 | 11061-0121 **S J**
CLUTCH COVER GASKET



P016000005180 | 11009-1974 **J**
IGNITION COVER GASKET (2000-2005)

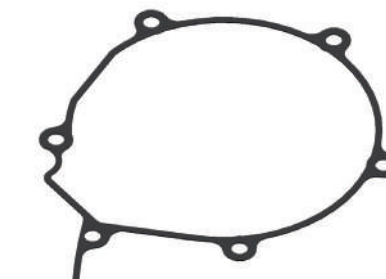

P016000005178 | 11061-0193 **J**
IGNITION COVER GASKET (2006->)



P014000005179 | 11060-1924 **S J**
WATER PUMP COVER GASKET (2000-2005)



P014000005176 | 11061-0159 **S J**
WATER PUMP COVER GASKET (2006->)



P014000005497 | 11061-1927
P014000005498 | 11061-0202 **S J**
WATER PUMP ELBOW GASKET (2000-2005)
WATER PUMP ELBOW GASKET (2006->)

ARTEIN PART No.	DESCRIPTION	UNITS	TOP END KIT K0000KW0K0824	SMART KIT S0000KW0S0824	COMPLETE SET J0000KW000824	ORIGINAL PART No.
P001000005196	CYLINDER HEAD GASKET	1	▪	▪	▪	11004-1360
P02D000005195	CYLINDER BASE GASKET (0,25 MM)	1	▪	▪	▪	-
P02E000005195	CYLINDER BASE GASKET (0,3 MM)	1	▪	▪	▪	-
P02F000005195	CYLINDER BASE GASKET (0,4 MM)	1	▪	▪	▪	11060-1779
P012000XR5203	EXHAUST GASKET	1	▪	▪	▪	11060-1842
X560003400350	O-RING (EXHAUST)	2	▪	▪	▪	670E3034
A801006511150	WASHER (CYLINDER HEAD)	1	▪	▪	▪	92022-304
P025000005200	EXHAUST VALVE COVER GASKET, FRONT SIDE	1	▪	▪	▪	92055-1566
P025000005201	EXHAUST VALVE COVER GASKET, RIGHT SIDE	1	▪	▪	▪	11060-1778
P018000005199	CLUTCH COVER GASKET	1	▪	▪	▪	11061-0122
P025000005198	FRICTION DISC COVER GASKET	1	▪	▪	▪	11060-1795
A801010016100	WASHER (OIL DRAIN)	1	▪	▪	▪	92065-058
A801006012100	WASHER (WATER PUMP)	3	▪	▪	▪	92022-077
P014000005205	WATER PUMP COVER GASKET	1	▪	▪	▪	11061-0184
P016000005206	IGNITION COVER GASKET	1	▪	▪	▪	11061-0194
X520001750150	O-RING (FRONT SPROCKET)	2	▪	▪	▪	92055-022

XRADICAL
SUPER GASKETS



P02D000005195 (0,25 mm)
P02E000005195 (0,3 mm)
P02F000005195 (0,4 mm) | 11060-1779
CYLINDER BASE GASKET

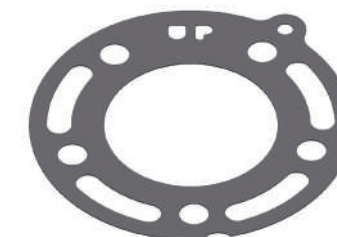

P001000005196 | 11004-1360
CYLINDER HEAD GASKET

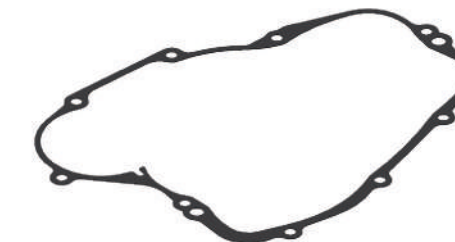

P018000005199 | 11061-0122
CLUTCH COVER GASKET



P025000005198 | 11060-1795
FRICTION DISC COVER GASKET

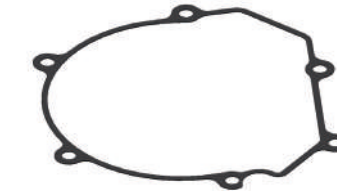

P016000005206 | 11061-0194
IGNITION COVER GASKET



P014000005205 | 11061-0184
WATER PUMP COVER GASKET



P025000005201 | 11060-1778
EXHAUST VALVE COVER GASKET, RIGHT SIDE



P025000005200 | 92055-1566
EXHAUST VALVE COVER GASKET, FRONT SIDE



P012000XR5203 | 11060-1842
EXHAUST GASKET

ARTEIN PART No.	DESCRIPTION	UNITS	TOP END KIT K0000KW0K0864	SMART KIT S0000KW0S0864	COMPLETE SET J0000KW000864	ORIGINAL PART No.
P001000005204	CYLINDER HEAD GASKET	1	▪	▪	▪	11004-0760
P02D000005195	CYLINDER BASE GASKET (0,25 MM)	1	▪	▪	▪	-
P02E000005195	CYLINDER BASE GASKET (0,3 MM)	1	▪	▪	▪	-
P02F000005195	CYLINDER BASE GASKET (0,4 MM)	1	▪	▪	▪	11060-1779
P012000XR5203	EXHAUST GASKET	1	▪	▪	▪	11060-1842
X560003400350	O-RING (EXHAUST)	2	▪	▪	▪	670E3034
A801006511150	WASHER (CYLINDER HEAD)	1	▪	▪	▪	92022-304
P025000005208	EXHAUST VALVE COVER GASKET, REAR SIDE	1	▪	▪	▪	11061-0889
P025000005201	EXHAUST VALVE COVER GASKET, RIGHT SIDE	1	▪	▪	▪	11060-1778
P018000005199	CLUTCH COVER GASKET	1	▪	▪	▪	11061-0122
P025000005198	FRICTION DISC COVER GASKET	1	▪	▪	▪	11061-0869
A801010016100	WASHER (OIL DRAIN)	1	▪	▪	▪	92065-058
A801006012100	WASHER (WATER PUMP)	3	▪	▪	▪	92022-077
P014000005205	WATER PUMP COVER GASKET	1	▪	▪	▪	11061-0184
P016000005206	IGNITION COVER GASKET	1	▪	▪	▪	11061-0194
X520001750150	O-RING (FRONT SPROCKET)	2	▪	▪	▪	92055-022

XRADICAL
SUPER GASKETS



P02D000005195 (0,25 mm)
P02E000005195 (0,3 mm)
P02F000005195 (0,4 mm) 11060-1779 **K S J**
CYLINDER BASE GASKET

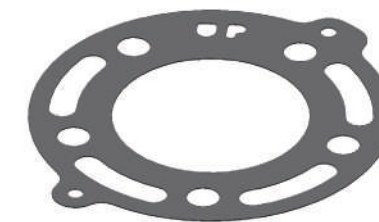

P001000005204 11004-0760 **K S J**
CYLINDER HEAD GASKET

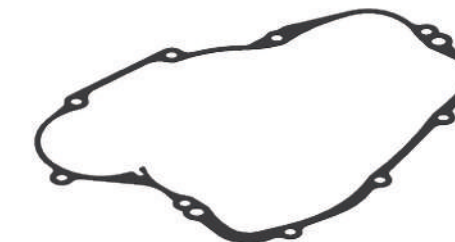

P018000005199 11061-0122 **S J**
CLUTCH COVER GASKET



P025000005198 11061-0869 **S J**
FRICTION DISC COVER GASKET

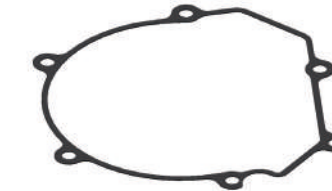

P016000005206 11061-0194 **J**
IGNITION COVER GASKET



P014000005205 11061-0184 **S J**
WATER PUMP COVER GASKET



P025000005201 11060-1778 **K S J**
EXHAUST VALVE COVER GASKET, RIGHT SIDE

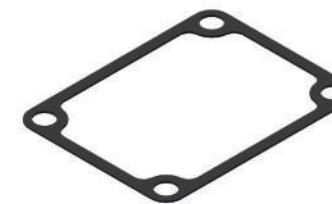

P025000005208 11061-0889 **K S J**
EXHAUST VALVE COVER GASKET, REAR SIDE



P012000XR5203 11060-1842 **K S J**
EXHAUST GASKET

ARTEIN PART No.	DESCRIPTION	UNITS	TOP END KIT K0000KW0K0826	SMART KIT S0000KW0S0826	COMPLETE SET J0000KW000826	ORIGINAL PART No.
P001000005219	CYLINDER HEAD GASKET	1	▪	▪	▪	11004-1249
P02G000005218	CYLINDER BASE GASKET	1	▪	▪	▪	11060-1740
P012000XR5220	EXHAUST GASKET	1	▪	▪	▪	11060-1203
X520001800200	O-RING (DISTRIBUTION TENSIONER)	1	▪	▪	▪	670B2018
X520001880190	O-RING (DISTRIBUTION TENSIONER)	1	▪	▪	▪	92055-086
X560004100250	O-RING (REED VALVE)	1	▪	▪	▪	92055-1255
A820008014100	WASHER (OIL PIPE)	4	▪	▪	▪	11009-1344
A820010014150	WASHER (OIL PIPE)	2	▪	▪	▪	11009-1105
KRV00KW0V0826	VALVE STEM SEALS KIT	1	▪	▪	▪	-
X520001950150	O-RING (WATER HOSE SEAL)	1	▪	▪	▪	92055-055
P025000005225	AIR SUCTION GASKET	2	▪	▪	▪	11060-1886
P018000005256	CLUTCH COVER GASKET	1	▪	▪	▪	11060-1324
P025000005223	FRICITION DISC COVER GASKET	1	▪	▪	▪	11060-1325
X520000950190	O-RING (WATER TEMP SENSOR)	1	▪	▪	▪	92055-0016
A801010016200	WASHER (OIL DRAIN)	1	▪	▪	▪	11061-0222
A801008014100	WASHER (OIL DRAIN)	1	▪	▪	▪	11061-0418
P014000005221	WATER PUMP COVER GASKET	1	▪	▪	▪	11060-1328
P031000005226	ELECTRIC START COVER GASKET	1	▪	▪	▪	11060-1641
P016000005257	IGNITION COVER GASKET	1	▪	▪	▪	11060-1326
X520002000200	O-RING (IGNITION COVER)	1	▪	▪	▪	92055-1146
X520002770240	O-RING (IGNITION COVER/SHIFT SENSOR)	2	▪	▪	▪	92055-091
X520005260240	O-RING (OIL FILTER)	1	▪	▪	▪	92055-1577
X520002150150	O-RING (FRONT SPROCKET)	1	▪	▪	▪	92055-0196
P011000005254	TRANSMISSION GEAR COVER GASKET	1	▪	▪	▪	11060-1327
A801010016100	WASHER (SHIFT SENSOR)	1	▪	▪	▪	11061-0373
X520001800300	O-RING (OIL FILLER CAP)	1	▪	▪	▪	92055-012

RELATED PRODUCTS

ARTEIN PART No.	DESCRIPTION
KRV00KW0V0826	VALVE STEM SEALS KIT

XRADICAL
SUPER GASKETS



▲ P02G000005218 | 11060-1740 **K S J**
CYLINDER BASE GASKET



▲ P001000005219 | 11004-1249 **K S J**
CYLINDER HEAD GASKET



▲ P012000XR5220 | 11060-1203 **K S J**
EXHAUST GASKET



▲ P018000005256 | 11060-1324 **S J**
CLUTCH COVER GASKET

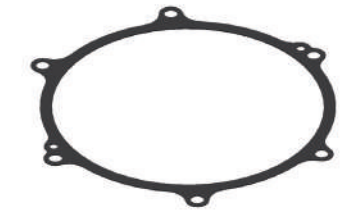

▲ P025000005223 | 11060-1325 **S J**
FRICITION DISC COVER GASKET

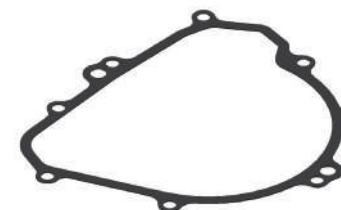

▲ P016000005257 | 11060-1326 **J**
IGNITION COVER GASKET

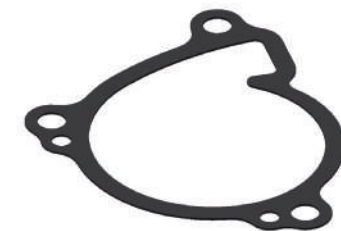

▲ P014000005221 | 11060-1328 **S J**
WATER PUMP COVER GASKET



▲ P011000005254 | 11060-1327 **J**
TRANSMISSION GEAR COVER GASKET



▲ P031000005226 | 11060-1641 **J**
ELECTRIC MOTOR COVER GASKET

ARTEIN PART No.	DESCRIPTION	UNITS	TOP END KIT K0000KW0K0827	SMART KIT S0000KW0S0827	COMPLETE SET J0000KW000827	ORIGINAL PART No.
P001000005219	CYLINDER HEAD GASKET	1	▪	▪	▪	11004-1249
P02G000005218	CYLINDER BASE GASKET	1	▪	▪	▪	11060-1740
P012000XR5220	EXHAUST GASKET	1	▪	▪	▪	11060-1203
X520001800200	O-RING (DISTRIBUTION TENSIONER)	1	▪	▪	▪	670B2018
X520001880190	O-RING (DISTRIBUTION TENSIONER)	1	▪	▪	▪	92055-086
X560004100250	O-RING (INTAKE)	1	▪	▪	▪	92055-1255
A820008014100	WASHER (OIL PIPE)	5	▪	▪	▪	11009-1344
A820010014150	WASHER (OIL PIPE)	2	▪	▪	▪	11009-1105
KRV00KW0V0826	VALVE STEM SEALS KIT	1	▪	▪	▪	-
X520001950150	O-RING (WATER HOSE SEAL)	1	▪	▪	▪	92055-055
P025000005225	AIR SUCTION GASKET	2	▪	▪	▪	11060-1886
P018000005222	CLUTCH COVER GASKET	1	▪	▪	▪	11061-0923
P025000005223	FRICITION DISC COVER GASKET	1	▪	▪	▪	11060-1325
X520000950190	O-RING (WATER TEMP SENSOR)	1	▪	▪	▪	92055-0016
A801010016200	WASHER (OIL DRAIN)	1	▪	▪	▪	11061-0222
A801008014100	WASHER (OIL DRAIN)	1	▪	▪	▪	11061-0418
P014000005221	WATER PUMP COVER GASKET	1	▪	▪	▪	11060-1328
P031000005226	ELECTRIC START COVER GASKET	1	▪	▪	▪	11061-0892
P016000005224	IGNITION COVER GASKET	1	▪	▪	▪	11061-0891
X520002000200	O-RING (IGNITION COVER)	1	▪	▪	▪	92055-1146
X520002770240	O-RING (IGNITION COVER)	1	▪	▪	▪	92055-091
X520005260240	O-RING (OIL FILTER)	1	▪	▪	▪	92055-1577
X520002150150	O-RING (FRONT SPROCKET)	1	▪	▪	▪	92055-0196
P011000005254	TRANSMISSION GEAR COVER GASKET	1	▪	▪	▪	11061-0897
A801010016100	WASHER (SHIFT SENSOR)	1	▪	▪	▪	11061-0373
X520001800300	O-RING (OIL FILLER CAP)	1	▪	▪	▪	92055-012

RELATED PRODUCTS

ARTEIN PART No.	DESCRIPTION
KRV00KW0V0826	VALVE STEM SEALS KIT

XRADICAL
SUPER GASKETS



▲ P02G000005218 | 11060-1740 **K S J**
CYLINDER BASE GASKET

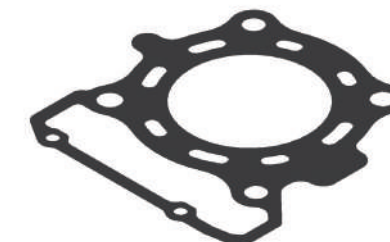

▲ P001000005219 | 11004-1249 **K S J**
CYLINDER HEAD GASKET



▲ P012000XR5220 | 11060-1203 **K S J**
EXHAUST GASKET



▲ P018000005222 | 11061-0923 **S J**
CLUTCH COVER GASKET

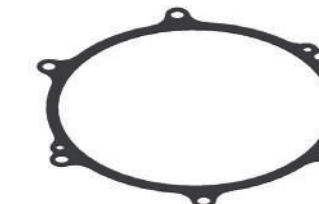

▲ P025000005223 | 11060-1325 **S J**
FRICITION DISC COVER GASKET



▲ P016000005224 | 11061-0891 **J**
IGNITION COVER GASKET



▲ P014000005221 | 11060-1328 **S J**
WATER PUMP COVER GASKET

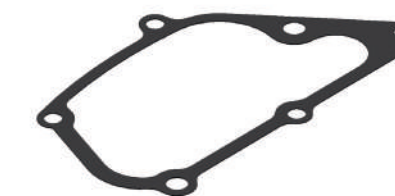

▲ P011000005254 | 11061-0897 **J**
TRANSMISSION GEAR COVER GASKET



▲ P031000005226 | 11061-0892 **J**
ELECTRIC MOTOR COVER GASKET

ARTEIN PART No.	DESCRIPTION	UNITS	TOP END KIT K0000KW0K0830	SMART KIT S0000KW0S0830	COMPLETE SET J0000KW000830	ORIGINAL PART No.
P001000005250	CYLINDER HEAD GASKET	1	▪	▪	▪	11004-0738
P02G000005242	CYLINDER BASE GASKET	1	▪	▪	▪	11061-0357
P012000XR5235	EXHAUST GASKET	1	▪	▪	▪	11061-0027
X520001880190	O-RING (DISTRIBUTION TENSIONER)	1	▪	▪	▪	92055-086
X520002350200	O-RING (SPARK PLUG)	1	▪	▪	▪	92055-0046
X520002460240	O-RING (SPARK PLUG)	1	▪	▪	▪	92055-0150
KRV00KW0V0826	VALVE STEM SEALS KIT	1	▪	▪	▪	-
X520001880240	O-RING (WATER HOSE SEAL)	1	▪	▪	▪	92055-1308
P018000005240	CLUTCH COVER GASKET	1	▪	▪	▪	11061-0361
P025000005241	FRICTION DISC COVER GASKET	1	▪	▪	▪	11061-0362
A801006511150	WASHER (WATER PUMP)	1	▪	▪	▪	92022-304
A820006010100	WASHER (WATER PUMP)	3	▪	▪	▪	92200-0190
P014000005236	WATER PUMP COVER GASKET	1	▪	▪	▪	92055-0010
P016000005243	IGNITION COVER GASKET	1	▪	▪	▪	11061-0778
X520001300200	O-RING (IGNITION COVER)	1	▪	▪	▪	92055-1021
X520002200240	O-RING (IGNITION COVER)	1	▪	▪	▪	670B2022
X520003500200	O-RING (OIL FILTER)	1	▪	▪	▪	92055-520
X520001950150	O-RING (FRONT SPROCKET)	2	▪	▪	▪	92055-055
A801010016100	WASHER (OIL DRAIN/SHIFT SENSOR)	2	▪	▪	▪	92065-058
X520002000200	O-RING (OIL FILLER CAP)	1	▪	▪	▪	92055-1146
X520002770240	O-RING (IGNITION COVER/SHIFT SENSOR) ('11-'16)	2	▪	▪	▪	92055-091

RELATED PRODUCTS

ARTEIN PART No.	DESCRIPTION
KRV00KW0V0826	VALVE STEM SEALS KIT

XRADICAL
SUPER GASKETS



▲ P02G000005242 | 11061-0357 **K S J**
CYLINDER BASE GASKET



▲ P001000005250 | 11004-0738 **K S J**
CYLINDER HEAD GASKET



▲ P012000XR5235 | 11061-0027 **K S J**
EXHAUST GASKET

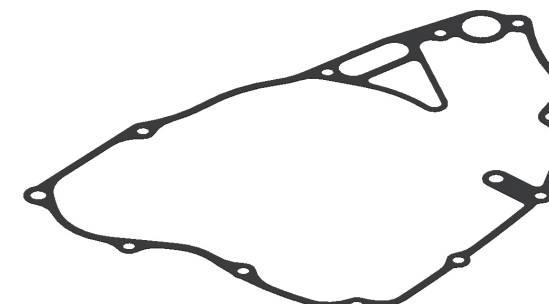

▲ P018000005240 | 11061-0361 **S J**
CLUTCH COVER GASKET

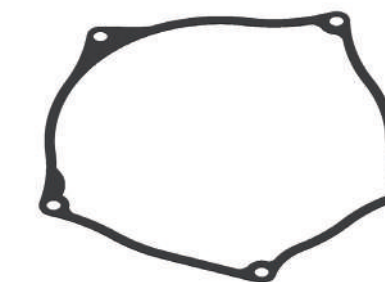

▲ P025000005241 | 11061-0362 **S J**
FRICTION DISC COVER GASKET



▲ P016000005243 | 11061-0778 **J**
IGNITION COVER GASKET



▲ P014000005236 | 92055-0010 **S J**
WATER PUMP COVER GASKET

ARTEIN PART No.	DESCRIPTION	UNITS	TOP END KIT K0000KW0K0831	SMART KIT S0000KW0S0831	COMPLETE SET J0000KW000831	ORIGINAL PART No.
P001000005234	CYLINDER HEAD GASKET	1	▪	▪	▪	11004-0761
P02G000005233	CYLINDER BASE GASKET	1	▪	▪	▪	11061-1198
P012000XR5235	EXHAUST GASKET	1	▪	▪	▪	11061-0027
X520001880190	O-RING (DISTRIBUTION TENSIONER)	1	▪	▪	▪	92055-086
X560004370190	O-RING (REED VALVE)	1	▪	▪	▪	92055-1401
KRV00KW0V0826	VALVE STEM SEALS KIT	1	▪	▪	▪	-
X520001880240	O-RING (WATER HOSE SEAL)	1	▪	▪	▪	92055-1308
P018000005237	CLUTCH COVER GASKET	1	▪	▪	▪	11061-1199
P025000005238	FRICTION DISC COVER GASKET	1	▪	▪	▪	11061-1201
X520000950190	O-RING (WATER TEMP SENSOR)	1	▪	▪	▪	92055-0016
A801006511150	WASHER (OIL DRAIN)	1	▪	▪	▪	92022-304
A801010016100	WASHER (OIL DRAIN)	1	▪	▪	▪	92065-058
A820006010100	WASHER (IGNITION COVER/WATER PUMP)	2	▪	▪	▪	92200-0190
P014000005236	WATER PUMP COVER GASKET	1	▪	▪	▪	92055-0010
P016000005239	IGNITION COVER GASKET	1	▪	▪	▪	11061-1200
X520001300200	O-RING (IGNITION COVER)	1	▪	▪	▪	92055-1021
X520002770240	O-RING (IGNITION COVER/SHIFT SENSOR)	2	▪	▪	▪	92055-091
X520003500200	O-RING (OIL FILTER)	1	▪	▪	▪	92055-520
X520001950150	O-RING (FRONT SPROCKET)	2	▪	▪	▪	92055-055
X520002000200	O-RING (OIL FILLER CAP)	1	▪	▪	▪	92055-1146

RELATED PRODUCTS

ARTEIN PART No.	DESCRIPTION
KRV00KW0V0826	VALVE STEM SEALS KIT

XRADICAL
SUPER GASKETS

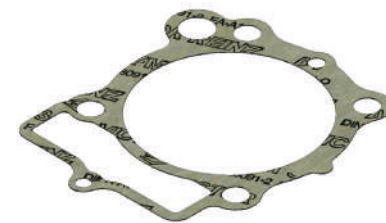

▲ P02G000005233 | 11061-1198 **K S J**
CYLINDER BASE GASKET



▲ P001000005234 | 11004-0761 **K S J**
CYLINDER HEAD GASKET



▲ P012000XR5235 | 11061-0027 **K S J**
EXHAUST GASKET

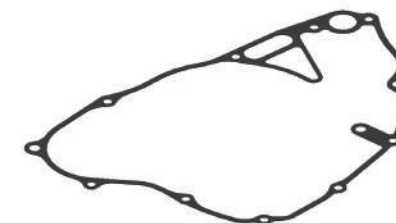

▲ P018000005237 | 11061-1199 **S J**
CLUTCH COVER GASKET



▲ P025000005238 | 11061-1201 **S J**
FRICTION DISC COVER GASKET



▲ P016000005239 | 11061-1200 **J**
IGNITION COVER GASKET



▲ P014000005236 | 92055-0010 **S J**
WATER PUMP COVER GASKET

ARTEIN PART No.	DESCRIPTION	UNITS	TOP END KIT K0000KW0K0825	SMART KIT S0000KW0S0825	COMPLETE SET J0000KW000825	ORIGINAL PART No.
P001000005212	CYLINDER HEAD GASKET	1	▪	▪	▪	11004-0088
P02G000005211	CYLINDER BASE GASKET	1	▪	▪	▪	11061-0160
P012000XR5213	EXHAUST GASKET	1	▪	▪	▪	11061-0082
P010000005245	DISTRIBUTION TENSIONER GASKET	1	▪	▪	▪	11061-0260
X520002350200	O-RING (SPARK PLUG)	1	▪	▪	▪	92055-0046
A801026030100	WASHER (WATER HOSE SEAL)	1	▪	▪	▪	92022-161
KRV00KW0V0825	VALVE STEM SEALS KIT	1	▪	▪	▪	-
X520001000250	O-RING (DISTRIBUTION TENSIONER)	1	▪	▪	▪	670D2010
P018000005215	CLUTCH COVER GASKET	1	▪	▪	▪	11061-0224
P025000005216	FRICTION DISC COVER GASKET	1	▪	▪	▪	11061-0259
A801006511150	WASHER (OIL DRAIN/WATER PUMP)	2	▪	▪	▪	92022-304
A801010016100	WASHER (OIL DRAIN)	1	▪	▪	▪	92065-058
P014000005229	WATER PUMP COVER GASKET	1	▪	▪	▪	11061-0225
A801007012100	WASHER (OIL DRAIN)	2	▪	▪	▪	92200-0171
P016000005217	IGNITION COVER GASKET	1	▪	▪	▪	11061-0271
X520000680200	O-RING (CRANKCASE)	1	▪	▪	▪	670D1507
X520001000250	O-RING (OIL FILTER)	1	▪	▪	▪	670D2010
X520006450300	O-RING (ELECTRIC START)	1	▪	▪	▪	671B2565
X520001300200	O-RING (IGNITION COVER)	1	▪	▪	▪	92055-1021
X520002770240	O-RING (IGNITION COVER/SHIFT SENSOR)	2	▪	▪	▪	92055-091
X520005260240	O-RING (OIL FILTER)	2	▪	▪	▪	92055-1577
X520002150150	O-RING (FRONT SPROCKET)	1	▪	▪	▪	92055-1293
X520002000200	O-RING (OIL FILLER CAP)	1	▪	▪	▪	92055-1146

RELATED PRODUCTS

ARTEIN PART No.	DESCRIPTION
KRV00KW0V0825	VALVE STEM SEALS KIT

XRADICAL
SUPER GASKETS



▲ P02G000005211 | 11061-0160 **K S J**
CYLINDER BASE GASKET



▲ P001000005212 | 11004-0088 **K S J**
CYLINDER HEAD GASKET



▲ P012000XR5213 | 11061-0082 **K S J**
EXHAUST GASKET

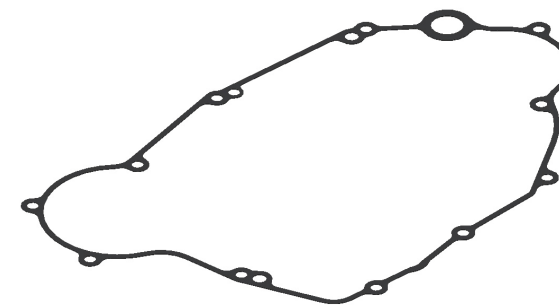

▲ P018000005215 | 11061-0224 **S J**
CLUTCH COVER GASKET

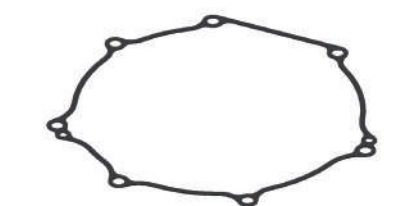

▲ P025000005216 | 11061-0259 **S J**
FRICTION DISC COVER GASKET

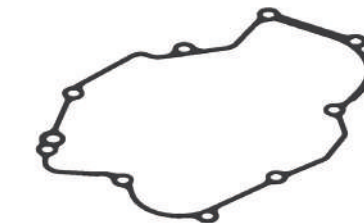

▲ P016000005217 | 11061-0271 **J**
IGNITION COVER GASKET



▲ P014000005229 | 11061-0225 **S J**
WATER PUMP COVER GASKET



▲ P010000005245 | 11061-0260 **K S J**
DISTRIBUTION CHAIN TENSIONER GASKET

ARTEIN PART No.	DESCRIPTION	UNITS	TOP END KIT K0000KW0K0828	SMART KIT S0000KW0S0828	COMPLETE SET J0000KW000828	ORIGINAL PART No.
P001000005212	CYLINDER HEAD GASKET	1	▪	▪	▪	11004-0088
P02G000005211	CYLINDER BASE GASKET	1	▪	▪	▪	11061-0160
P012000XR5213	EXHAUST GASKET	1	▪	▪	▪	11061-0082
P010000005245	DISTRIBUTION TENSIONER GASKET	1	▪	▪	▪	11061-0260
X520002350200	O-RING (SPARK PLUG)	1	▪	▪	▪	92055-0046
A801026030100	WASHER (WATER HOSE SEAL)	1	▪	▪	▪	92022-161
X520001000250	O-RING (DISTRIBUTION TENSIONER)	1	▪	▪	▪	670D2010
KRV00KW0V0825	VALVE STEM SEALS KIT	1	▪	▪	▪	-
P018000005215	CLUTCH COVER GASKET	1	▪	▪	▪	11061-0224
P025000005216	FRICTION DISC COVER GASKET	1	▪	▪	▪	11061-0259
A801006511150	WASHER (OIL DRAIN/WATER PUMP)	2	▪	▪	▪	92022-304
A801010016100	WASHER (OIL DRAIN)	1	▪	▪	▪	92065-058
A801007012100	WASHER (OIL DRAIN)	1	▪	▪	▪	92200-0171
P014000005229	WATER PUMP COVER GASKET	1	▪	▪	▪	11061-0225
P016000005249	IGNITION COVER GASKET	1	▪	▪	▪	11061-0084
X520000680200	O-RING (CRANKCASE)	1	▪	▪	▪	670D1507
X520001000250	O-RING (OIL FILTER)	1	▪	▪	▪	670D2010
X520001300200	O-RING (IGNITION COVER)	1	▪	▪	▪	92055-1021
X520002770240	O-RING (IGNITION COVER/SHIFT SENSOR)	2	▪	▪	▪	92055-091
X520005260240	O-RING (OIL FILTER)	2	▪	▪	▪	92055-1577
X520002150150	O-RING (FRONT SPROCKET)	1	▪	▪	▪	92055-1293
X520002000200	O-RING (OIL FILLER CAP)	1	▪	▪	▪	92055-1146

RELATED PRODUCTS

ARTEIN PART No.	DESCRIPTION
KRV00KW0V0825	VALVE STEM SEALS KIT

XRADICAL
SUPER GASKETS



▲ P02G000005211 | 11061-0160 K S J
CYLINDER BASE GASKET



▲ P001000005212 | 11004-0088 K S J
CYLINDER HEAD GASKET



▲ P012000XR5213 | 11061-0082 K S J
EXHAUST GASKET

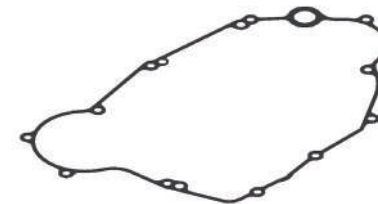

▲ P018000005215 | 11061-0224 S J
CLUTCH COVER GASKET

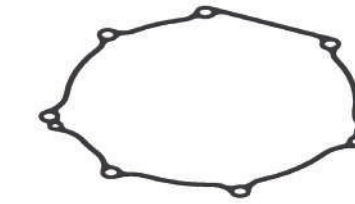

▲ P025000005216 | 11061-0259 S J
FRICTION DISC COVER GASKET

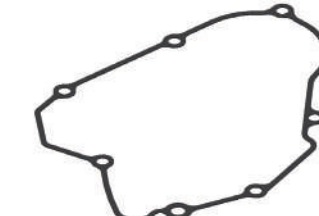

▲ P016000005249 | 11061-0084 J
IGNITION COVER GASKET



▲ P010000005245 | 11061-0260 K S J
DISTRIBUTION CHAIN TENSIONER GASKET



▲ P014000005229 | 11061-0225 S J
WATER PUMP COVER GASKET

ARTEIN PART No.	DESCRIPTION	UNITS	TOP END KIT K0000KW0K0865	SMART KIT S0000KW0S0865	COMPLETE SET J0000KW000865	ORIGINAL PART No.
P001000005212	CYLINDER HEAD GASKET	1	▪	▪	▪	11004-0088
P02G000005246	CYLINDER BASE GASKET	1	▪	▪	▪	11061-0768
P012000XR5213	EXHAUST GASKET	1	▪	▪	▪	11061-0082
P010000005245	DISTRIBUTION TENSIONER GASKET	1	▪	▪	▪	11061-0260
X520001000250	O-RING (DISTRIBUTION TENSIONER)	1	▪	▪	▪	670D2010
X560004700190	O-RING (INTAKE)	1	▪	▪	▪	92055-1600
X520002350200	O-RING (SPARK PLUG)	1	▪	▪	▪	92055-0046
A801026030100	WASHER (WATER HOSE SEAL)	1	▪	▪	▪	92022-161
KRV00KW0V0825	VALVE STEM SEALS KIT	1	▪	▪	▪	-
P018000005248	CLUTCH COVER GASKET	1	▪	▪	▪	11061-0853
P025000005216	FRICITION DISC COVER GASKET	1	▪	▪	▪	11061-0259
X520000950190	O-RING (WATER TEMP SENSOR)	1	▪	▪	▪	92055-0016
A801006511150	WASHER (OIL DRAIN/WATER PUMP)	2	▪	▪	▪	92022-304
A801010016100	WASHER (OIL DRAIN)	1	▪	▪	▪	92065-058
A801007012100	WASHER (OIL DRAIN)	2	▪	▪	▪	92200-0171
P014000005229	WATER PUMP COVER GASKET	1	▪	▪	▪	11061-0225
P016000005252	IGNITION COVER GASKET	1	▪	▪	▪	11061-0852
X520000680200	O-RING (CRANKCASE)	1	▪	▪	▪	670D1507
X520000800200	O-RING (CRANKCASE)	1	▪	▪	▪	670D1508
X520001000250	O-RING (OIL FILTER)	1	▪	▪	▪	670D2010
X520001300200	O-RING (IGNITION COVER)	1	▪	▪	▪	92055-1021
X520002770240	O-RING (IGNITION COVER/SHIFT SENSOR)	2	▪	▪	▪	92055-091
X520005260240	O-RING (OIL FILTER)	2	▪	▪	▪	92055-1577
X520002150150	O-RING (FRONT SPROCKET)	1	▪	▪	▪	92055-1293
X520002000200	O-RING (OIL FILLER CAP)	1	▪	▪	▪	92055-1146

RELATED PRODUCTS

ARTEIN PART No.	DESCRIPTION
KRV00KW0V0825	VALVE STEM SEALS KIT

XRADICAL
SUPER GASKETS



▲ P02G000005246 | 11061-0768 **K S J**
CYLINDER BASE GASKET



▲ P001000005212 | 11004-0088 **K S J**
CYLINDER HEAD GASKET



▲ P012000XR5213 | 11061-0082 **K S J**
EXHAUST GASKET

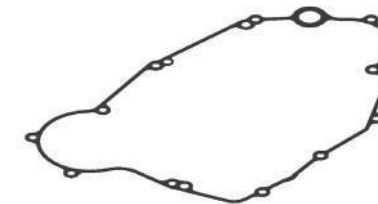

▲ P018000005248 | 11061-0853 **S J**
CLUTCH COVER GASKET

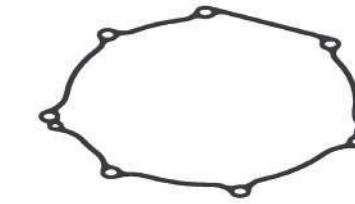

▲ P025000005216 | 11061-0259 **S J**
FRICITION DISC COVER GASKET

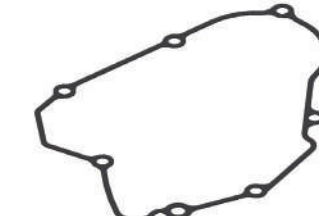

▲ P016000005252 | 11061-0852 **J**
IGNITION COVER GASKET



▲ P010000005245 | 11061-0260 **K S J**
DISTRIBUTION CHAIN TENSIONER GASKET



▲ P014000005229 | 11061-0225 **S J**
WATER PUMP COVER GASKET

ARTEIN PART No.	DESCRIPTION	UNITS	TOP END KIT K0000KW0K0829	SMART KIT S0000KW0S0829	COMPLETE SET J0000KW000829	ORIGINAL PART No.
P001000005228	CYLINDER HEAD GASKET	1	▪	▪	▪	11004-0756
P02G000005227	CYLINDER BASE GASKET	1	▪	▪	▪	11061-0984
P012000XR5213	EXHAUST GASKET	1	▪	▪	▪	11061-0082
P010000005245	DISTRIBUTION TENSIONER GASKET	1	▪	▪	▪	11061-0260
X520001000250	O-RING (DISTRIBUTION TENSIONER)	1	▪	▪	▪	670D2010
X560004700190	O-RING (INTAKE)	1	▪	▪	▪	92055-1600
X520002350200	O-RING (SPARK PLUG)	1	▪	▪	▪	92055-0046
A801026030100	WASHER (WATER HOSE SEAL)	1	▪	▪	▪	92022-161
KRV00KW0V0825	VALVE STEM SEALS KIT	1	▪	▪	▪	-
P018000005230	CLUTCH COVER GASKET	1	▪	▪	▪	11061-0981
X520016300190	O-RING (FRICTION DISC COVER GASKET)	1	▪	▪	▪	92055-0833
X520000950190	O-RING (WATER TEMP SENSOR)	1	▪	▪	▪	92055-0016
A801006511150	WASHER (WATER PUMP)	1	▪	▪	▪	92022-304
A801010016100	WASHER (OIL DRAIN)	1	▪	▪	▪	92065-058
A801007012100	WASHER (OIL DRAIN)	2	▪	▪	▪	92200-1743
P014000005244	WATER PUMP COVER GASKET	1	▪	▪	▪	11061-0983
P016000005232	IGNITION COVER GASKET	1	▪	▪	▪	11061-0982
X520000680200	O-RING (CRANKCASE)	1	▪	▪	▪	670D1507
X520000800200	O-RING (CRANKCASE)	1	▪	▪	▪	670D1508
X520001000200	O-RING (CRANKCASE/OIL FILTER)	2	▪	▪	▪	670D1510
X520001000250	O-RING (OIL FILTER)	1	▪	▪	▪	670D2010
X520001300200	O-RING (IGNITION COVER/OIL FILTER)	2	▪	▪	▪	92055-1021
X520002770240	O-RING (IGNITION COVER)	2	▪	▪	▪	92055-091
X520003720240	O-RING (OIL FILTER)	1	▪	▪	▪	92055-0839
X520002150150	O-RING (FRONT SPROCKET)	1	▪	▪	▪	92055-1293
X520002000200	O-RING (OIL FILLER CAP)	1	▪	▪	▪	92055-1146

RELATED PRODUCTS

ARTEIN PART No.	DESCRIPTION
KRV00KW0V0825	VALVE STEM SEALS KIT

XRADICAL
SUPER GASKETS

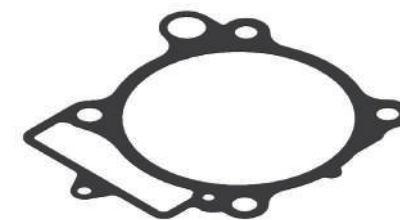

▲ P02G000005227 | 11061-0984 **K S J**
CYLINDER BASE GASKET



▲ P001000005228 | 11004-0756 **K S J**
CYLINDER HEAD GASKET



▲ P012000XR5213 | 11061-0082 **K S J**
EXHAUST GASKET

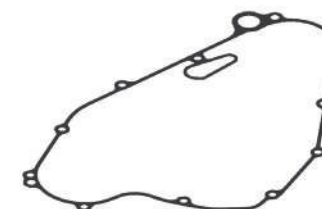

▲ P018000005230 | 11061-0981 **S J**
CLUTCH COVER GASKET



▲ P016000005232 | 11061-0982 **J**
IGNITION COVER GASKET



▲ P014000005244 | 11061-0983 **S J**
WATER PUMP COVER GASKET



▲ P010000005245 | 11061-0260 **K S J**
DISTRIBUTION CHAIN TENSIONER GASKET

ARTEIN PART No.	DESCRIPTION	UNITS	TOP END KIT K0000KT0K0801	SMART KIT S0000KT0S0801	COMPLETE SET J0000KT000801	ORIGINAL PART No.
X560005200200	O-RING (CYLINDER HEAD GASKET, INNER)	1	▪	▪	▪	0770052020
X560007800200	O-RING (CYLINDER HEAD GASKET, OUTER)	1	▪	▪	▪	0770078020
P02D000005129	CYLINDER BASE GASKET (0,25 MM)	1	▪	▪	▪	46230035020
P02F000005129	CYLINDER BASE GASKET (0,4 MM)	1	▪	▪	▪	46230035040
P02G000005129	CYLINDER BASE GASKET (0,5 MM)	1	▪	▪	▪	46230035050
P02H000005129	CYLINDER BASE GASKET (0,6 MM)	1	▪	▪	▪	46230035060
P012000005130	EXHAUST GASKET	1	▪	▪	▪	45205004000
X560003000300	O-RING (EXHAUST)	2	▪	▪	▪	0770300030
X560001200300	O-RING (SPARK PLUG)	1	▪	▪	▪	0770012030
A820007012100	WASHER (CYLINDER HEAD)	5	▪	▪	▪	50230032010
P015000005024	REED VALVE GASKET	1	▪	▪	▪	46230049000
P018000005127	CLUTCH COVER GASKET	1	▪	▪	▪	45230025000
P025000005128	FRICTION DISC COVER GASKET	1	▪	▪	▪	45230027000
A820012018150	WASHER (OIL DRAIN)	1	▪	▪	▪	58038022000
A820006010100	WASHER (WATER PUMP/FRICTION DISC COVER)	2	▪	▪	▪	0603061001
P014000005025	WATER PUMP COVER GASKET	1	▪	▪	▪	45235053000
P003000005126	CRANKCASE GASKET	1	▪	▪	▪	45230039000
P016000005134	IGNITION COVER GASKET	1	▪	▪	▪	45230040000
X520001500178	O-RING (FRONT SPROCKET)	1	▪	▪	▪	0770015018
X520001900300	O-RING (OIL FILLER CAP)	1	▪	▪	▪	0770191015

XRADICAL
SUPER GASKETS



P02D000005129 | 46230035020 (0,25 mm)
P02F000005129 | 46230035040 (0,4 mm)
P02G000005129 | 46230035050 (0,5 mm)
P02H000005129 | 46230035060 (0,6 mm)

CYLINDER BASE GASKET

K S J



P012000005130 | 45205004000

EXHAUST GASKET

K S J

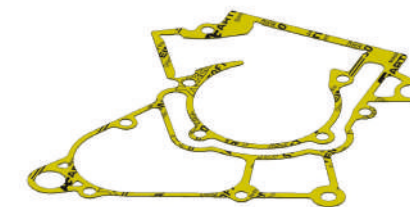

P003000005126 | 45230039000

CRANKCASE GASKET

J

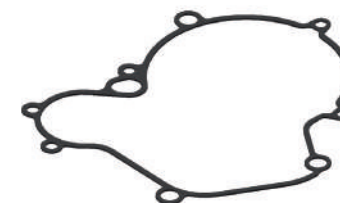

P018000005127 | 45230025000

CLUTCH COVER GASKET

S J



P025000005128 | 45230027000

FRICTION DISC COVER GASKET

S J



P016000005134 | 45230040000

IGNITION COVER GASKET

J



P014000005025 | 45235053000

WATER PUMP COVER GASKET

S J

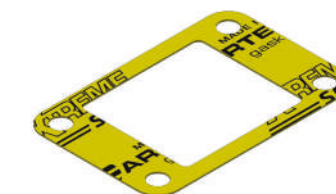

P015000005024 | 46230049000

REED VALVE GASKET

K S J

ARTEIN PART No.	DESCRIPTION	UNITS	TOP END KIT K0000KT0K0802	SMART KIT S0000KT0S0802	COMPLETE SET J0000KT000802	ORIGINAL PART No.
P001000005023	CYLINDER HEAD GASKET	1	▪	▪	▪	45230036000
P02D000005129	CYLINDER BASE GASKET (0,25 MM)	1	▪	▪	▪	46230035020
P02F000005129	CYLINDER BASE GASKET (0,4 MM)	1	▪	▪	▪	46230035040
P02G000005129	CYLINDER BASE GASKET (0,5 MM)	1	▪	▪	▪	46230035050
P02H000005129	CYLINDER BASE GASKET (0,6 MM)	1	▪	▪	▪	46230035060
P012000005135	EXHAUST GASKET	1	▪	▪	▪	46205004000
X560003500300	O-RING (EXHAUST)	2	▪	▪	▪	0770350030
X560001200300	O-RING (SPARK PLUG)	1	▪	▪	▪	0770012030
A820007012100	WASHER (CYLINDER HEAD)	4	▪	▪	▪	0603070121
P015000005024	REED VALVE GASKET	1	▪	▪	▪	46230049000
X560001500150	O-RING (EXHAUST VALVE CONTROL)	1	▪	▪	▪	0770150151
A820006010100	WASHER (EXHAUST CONTROL)	1	▪	▪	▪	0603061001
P018000005020	CLUTCH COVER GASKET	1	▪	▪	▪	46230025100
P025000005021	FRICTION DISC COVER GASKET	1	▪	▪	▪	46230027000
A820012018150	WASHER (OIL DRAIN)	1	▪	▪	▪	58038022000
A820006010100	WASHER (WATER PUMP)	1	▪	▪	▪	0603061001
P014000005025	WATER PUMP COVER GASKET	1	▪	▪	▪	45235053000
P025000005057	CLUTCH SLAVE GASKET	1	▪	▪	▪	59032065000
P003000005019	CRANKCASE GASKET	1	▪	▪	▪	46230039000
P016000005026	IGNITION COVER GASKET	1	▪	▪	▪	46230040000
X520003147178	O-RING (CLUTCH SLAVE)	1	▪	▪	▪	0770031018
X560002000200	O-RING (FRONT SPROCKET)	1	▪	▪	▪	0770020020
A820006010100	WASHER (CRANKCASE)	1	▪	▪	▪	0603061001
X520001900300	O-RING (OIL FILLER CAP)	1	▪	▪	▪	0770191015



P02D000005129 | 46230035020 (0,25 mm)
 P02F000005129 | 46230035040 (0,4 mm)
 P02G000005129 | 46230035050 (0,5 mm)
 P02H000005129 | 46230035060 (0,6 mm)

CYLINDER BASE GASKET



P001000005023 | 45230036000

CYLINDER HEAD GASKET



P012000005135 | 46205004000

EXHAUST GASKET

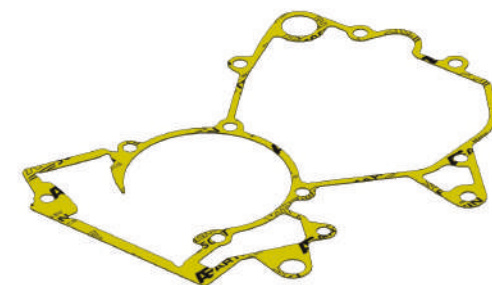

P003000005019 | 46230039000

CRANKCASE GASKET



P018000005020 | 46230025100

CLUTCH COVER GASKET



P025000005021 | 46230027000

FRICTION DISC COVER GASKET



P016000005026 | 46230040000

IGNITION COVER GASKET



P014000005025 | 45235053000

WATER PUMP COVER GASKET

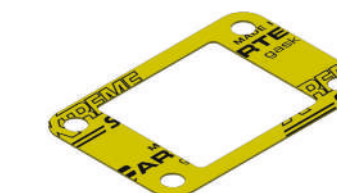

P015000005024 | 46230049000

REED VALVE GASKET

XRADICAL
 SUPER GASKETS

ARTEIN PART No.	DESCRIPTION	UNITS	TOP END KIT K0000KT0K0803	SMART KIT S0000KT0S0803	COMPLETE SET J0000KT000803	ORIGINAL PART No.
X560005400200	O-RING (CYLINDER HEAD GASKET, INNER)	1	▪	▪	▪	0770540020
X560008200200	O-RING (CYLINDER HEAD GASKET, OUTER) ('04-'12)	1	▪	▪	▪	0770820020
X560008000200	O-RING (CYLINDER HEAD GASKET, OUTER) ('13-'17)	1	▪	▪	▪	0770800021
X560002200250	O-RING (CYLINDER HEAD GASKET, UPPER)	1	▪	▪	▪	0770220025
P02D000005038	CYLINDER BASE GASKET (0,25 MM)	1	▪	▪	▪	47030035020
P02E000005038	CYLINDER BASE GASKET (0,3 MM)	1	▪	▪	▪	47030035030
P02G000005038	CYLINDER BASE GASKET (0,5 MM)	1	▪	▪	▪	47030035000
X560003800300	O-RING (EXHAUST)	2	▪	▪	▪	0770380030
A820006010100	WASHER (CYLINDER HEAD)	6	▪	▪	▪	0603061001
P015000005040	REED VALVE GASKET	1	▪	▪	▪	47030049000
P025000005503	EXHAUST VALVE COVER GASKET ('04-'12)	1	▪	▪	▪	47037008000
P025000005039	EXHAUST VALVE COVER GASKET ('13-'17)	1	▪	▪	▪	47137008000
X520000800150	O-RING (EXHAUST VALVE)	1	▪	▪	▪	0770008015
X520001200200	O-RING (EXHAUST VALVE)	1	▪	▪	▪	0770120020
A820006010100	WASHER (FRICTION DISC COVER)	1	▪	▪	▪	0603061001
A820006010100	WASHER (WATER PUMP)	1	▪	▪	▪	0603061001
P018000005035	CLUTCH COVER GASKET	1	▪	▪	▪	47030025000
P025000005036	FRICTION DISC COVER GASKET	1	▪	▪	▪	47030027100
A820010014200	WASHER (OIL DRAIN)	1	▪	▪	▪	0603101420
P014000005037	WATER PUMP COVER GASKET	1	▪	▪	▪	47035053000
X520001600300	O-RING (OIL FILLER CAP)	1	▪	▪	▪	0770160030
P003000005034	CRANKCASE GASKET	1	▪	▪	▪	47030039000
P016000005137	IGNITION COVER GASKET	1	▪	▪	▪	47030040000
X520002195178	O-RING (CENTRIFUGAL COVER)	1	▪	▪	▪	0770020200
X520003000150	O-RING (CLUTCH SLAVE)	1	▪	▪	▪	0770300015
X520003147178	O-RING (CLUTCH SLAVE)	1	▪	▪	▪	0770031018
X520001877178	O-RING (FRONT SPROCKET/PRIMARY GEAR)	2	▪	▪	▪	46033031000



P02D000005038 | 47030035020 (0,25 mm)
 P02E000005038 | 47030035030 (0,3 mm)
 P02G000005038 | 47030035000 (0,5 mm) **K S J**
 CYLINDER BASE GASKET

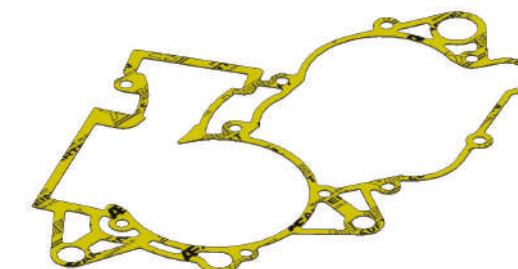

P003000005034 | 47030039000 **J**
 CRANKCASE GASKET

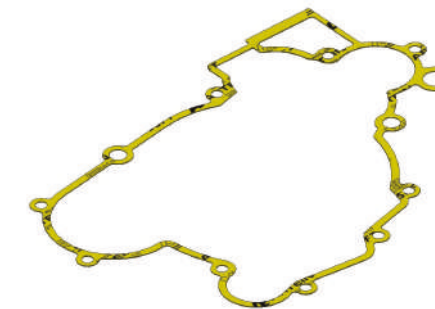

P018000005035 | 47030025000 **S J**
 CLUTCH COVER GASKET



P025000005036 | 47030027100 **S J**
 FRICTION DISC COVER GASKET



P016000005137 | 47030040000 **J**
 IGNITION COVER GASKET

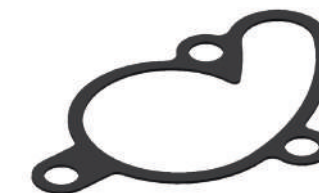

P014000005037 | 47035053000 **S J**
 WATER PUMP COVER GASKET



P025000005503 (2004 - 12) | 47037008000
 P025000005039 (2013 - 17) | 47137008000 **K S J**
 EXHAUST VALVE GASKET



P015000005040 | 47030049000 **K S J**
 REED VALVE GASKET

ARTEIN PART No.	DESCRIPTION	UNITS	TOP END KIT K0000KT0K0804	SMART KIT S0000KT0S0804	COMPLETE SET J0000KT000804	ORIGINAL PART No.
X560005400200	O-RING (CYLINDER HEAD GASKET, INNER)	1	▪	▪	▪	0770540020
X560008000200	O-RING (CYLINDER HEAD GASKET, OUTER)	1	▪	▪	▪	0770800021
X520002300250	O-RING (CYLINDER HEAD GASKET, UPPER)	1	▪	▪	▪	07702300251
P02D000005030	CYLINDER BASE GASKET (0,25 MM)	1	▪	▪	▪	47230035020
P02F000005030	CYLINDER BASE GASKET (0,4 MM)	1	▪	▪	▪	47230035040
P02G000005030	CYLINDER BASE GASKET (0,5 MM)	1	▪	▪	▪	47230035050
P02I000005030	CYLINDER BASE GASKET (0,8 MM)	1	▪	▪	▪	47230035075
P025000005032	EXHAUST VALVE COVER GASKET, LEFT SIDE	1	▪	▪	▪	47237006000
P025000005031	EXHAUST VALVE COVER GASKET, RIGHT SIDE	1	▪	▪	▪	47237008000
X560003800300	O-RING (EXHAUST)	2	▪	▪	▪	0770380030
A820006010100	WASHER (CYLINDER HEAD/FRONT EXHAUST VALVE)	8	▪	▪	▪	0603061001
X560000800200	O-RING (EXHAUST VALVE)	2	▪	▪	▪	0770080201
P015000005033	REED VALVE GASKET	1	▪	▪	▪	47230049000
P018000005027	CLUTCH COVER GASKET	1	▪	▪	▪	47230025000
P025000005028	FRICITION DISC COVER GASKET	1	▪	▪	▪	47230027000
A820012018150	WASHER (OIL DRAIN)	1	▪	▪	▪	58038022000
A820006010100	WASHER (FRICITION DISC COVER)	1	▪	▪	▪	0603061001
P014000005029	WATER PUMP COVER GASKET	1	▪	▪	▪	47235053000
A820006010100	WASHER (WATER PUMP)	1	▪	▪	▪	0603061001
P003000005138	CRANKCASE GASKET	1	▪	▪	▪	47230039000
X520002400200	O-RING (CENTRIFUGAL COVER)	1	▪	▪	▪	0770240020
X520003000150	O-RING (CLUTCH SLAVE)	1	▪	▪	▪	0770300015
X520001877178	O-RING (FRONT SPROCKET)	1	▪	▪	▪	0770020180
X520002100200	O-RING (PRIMARY GEAR)	1	▪	▪	▪	0770210020
X520001900300	O-RING (OIL FILLER CAP)	1	▪	▪	▪	0770191015



P02D000005030 | 47230035020 (0,25 mm)
 P02F000005030 | 47230035040 (0,4 mm)
 P02G000005030 | 47230035050 (0,5 mm)
 P02I000005030 | 47230035075 (0,8 mm)

CYLINDER BASE GASKET

K S J

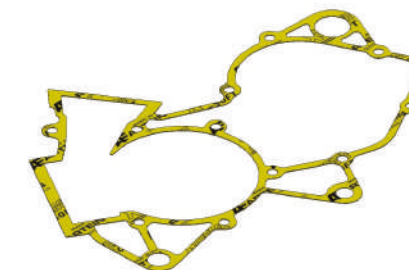

P003000005138 | 47230039000

CRANKCASE GASKET

J

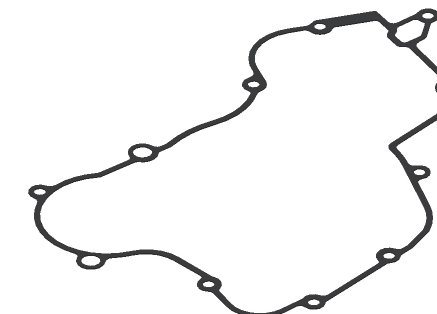

P018000005027 | 47230025000

CLUTCH COVER GASKET

S J



P025000005028 | 47230027000

FRICITION DISC COVER GASKET

S J



P014000005029 | 47235053000

WATER PUMP COVER GASKET

S J



P025000005031 | 47237008000

EXHAUST VALVE COVER GASKET, RIGHT SIDE

K S J



P025000005032 | 47237006000

EXHAUST VALVE COVER GASKET, LEFT SIDE

K S J



P015000005033 | 47230049000

REED VALVE GASKET

K S J

XRADICAL
 SUPER GASKETS

ARTEIN PART No.	DESCRIPTION	UNITS	TOP END KIT K0000KT0K0870	SMART KIT S0000KT0S0870	COMPLETE SET J0000KT000870	ORIGINAL PART No.
X560006200200	O-RING (CYLINDER HEAD GASKET, INNER)	1	▪	▪	▪	0770062020
P001000005521	CYLINDER HEAD GASKET (OUTER)	1	▪	▪	▪	50330137000
P02D000005356	CYLINDER BASE GASKET (0,25 MM)	1	▪	▪	▪	50330035025
P02F000005356	CYLINDER BASE GASKET (0,4 MM)	1	▪	▪	▪	50330035040
P02G000005356	CYLINDER BASE GASKET (0,5 MM)	1	▪	▪	▪	50330035050
P02I000005356	CYLINDER BASE GASKET (0,8 MM)	1	▪	▪	▪	50330035075
X560004400300	O-RING (EXHAUST PIPE)	2	▪	▪	▪	0770440030
A820006010100	WASHER (CYLINDER HEAD)	2	▪	▪	▪	0603061001
A820007012100	WASHER (CYLINDER HEAD)	6	▪	▪	▪	50230032010
P015000005358	REED VALVE GASKET	1	▪	▪	▪	50330098050
P025000005518	EXHAUST VALVE COVER GASKET, RIGHT SIDE	1	▪	▪	▪	50337006000
P025000005519	EXHAUST VALVE COVER GASKET, LEFT SIDE	1	▪	▪	▪	50337008000
P025000005361	EXHAUST VALVE COVER GASKET, LEVER	1	▪	▪	▪	50337035050
P025000005520	EXHAUST VALVE COVER GASKET, FRONT SIDE	1	▪	▪	▪	50337046100
X520000800200	O-RING (EXHAUST VALVE)	2	▪	▪	▪	0770008020
P018000005363	CLUTCH COVER GASKET	1	▪	▪	▪	50330025000
P025000005364	FRICITION DISC COVER GASKET	1	▪	▪	▪	50330027000
A820012018150	WASHER (OIL DRAIN)	1	▪	▪	▪	58038022000
A820010014100	WASHER (WATER PUMP)	2	▪	▪	▪	0603100141
X520001600300	O-RING (WATER PUMP)	1	▪	▪	▪	0770160030
P025000005365	CLUTCH SLAVE GASKET	1	▪	▪	▪	50332065053
P003000005362	CRANKCASE GASKET	1	▪	▪	▪	50330039000
P016000005505	IGNITION COVER GASKET	1	▪	▪	▪	50330040100
X520002300200	O-RING (FRONT SPROCKET)	1	▪	▪	▪	0770230020
X520001600300	O-RING (OIL FILLER CAP)	1	▪	▪	▪	0770160030



P02D000005356 | 50330035025 (0,25 mm)
 P02F000005356 | 50330035040 (0,4 mm)
 P02G000005356 | 50330035050 (0,5 mm)
 P02I000005356 | 50330035075 (0,8 mm)

CYLINDER BASE GASKET

K S J

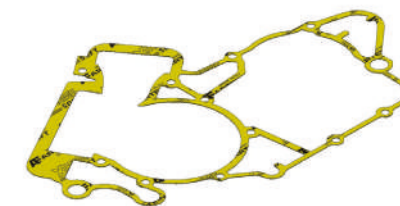

P003000005362 | 50330039000

CRANKCASE GASKET

J



P018000005363 | 50330025000

CLUTCH COVER GASKET

S J



P025000005364 | 50330027000

FRICITION DISC COVER GASKET

S J



P016000005505 | 50330040100

IGNITION COVER GASKET

J



P025000005361 | 50337035050

EXHAUST VALVE GASKET, LEVER

K S J



P025000005518 | 50337006000

EXHAUST VALVE GASKET, RIGHT SIDE

K S J



P025000005519 | 50337008000

EXHAUST VALVE GASKET, LEFT SIDE

K S J



P025000005520 | 50337046100

EXHAUST VALVE GASKET, FRONT SIDE

K S J

XRADICAL
 SUPER GASKETS

ARTEIN PART No.	DESCRIPTION	UNITS	TOP END KIT K0000KT0K0845	SMART KIT S0000KT0S0845	COMPLETE SET J0000KT000845	ORIGINAL PART No.
X560006200200	O-RING (CYLINDER HEAD GASKET, INNER)	1	▪	▪	▪	0770062020
X560008600200	O-RING (CYLINDER HEAD GASKET, OUTER)	1	▪	▪	▪	0770086020
X560001200200	O-RING (CYLINDER HEAD GASKET, UPPER)	1	▪	▪	▪	0770012021
P02D000005356	CYLINDER BASE GASKET (0,25 MM)	1	▪	▪	▪	50330035025
P02F000005356	CYLINDER BASE GASKET (0,4 MM)	1	▪	▪	▪	50330035040
P02G000005356	CYLINDER BASE GASKET (0,5 MM)	1	▪	▪	▪	50330035050
P02I000005356	CYLINDER BASE GASKET (0,8 MM)	1	▪	▪	▪	50330035075
X560004400300	O-RING (EXHAUST PIPE)	2	▪	▪	▪	0770440030
A820006010100	WASHER (CYLINDER HEAD)	2	▪	▪	▪	0603061001
A820007012100	WASHER (CYLINDER HEAD)	6	▪	▪	▪	50230032010
P015000005358	REED VALVE GASKET	1	▪	▪	▪	50330098050
P025000005357	EXHAUST VALVE COVER GASKET, FRONT SIDE	1	▪	▪	▪	50337046300
P025000005360	EXHAUST VALVE COVER GASKET, LEFT SIDE	1	▪	▪	▪	50337008100
P025000005361	EXHAUST VALVE COVER GASKET, LEVER	1	▪	▪	▪	50337035050
P025000005359	EXHAUST VALVE COVER GASKET, RIGHT SIDE	1	▪	▪	▪	50337006100
X520000800200	O-RING (EXHAUST VALVE)	2	▪	▪	▪	0770008020
P018000005363	CLUTCH COVER GASKET	1	▪	▪	▪	50330025000
P025000005364	FRICTION DISC COVER GASKET	1	▪	▪	▪	50330027000
A820012018150	WASHER (OIL DRAIN)	1	▪	▪	▪	58038022000
X520004900250	O-RING (WATER PUMP)	1	▪	▪	▪	0770049025
X520001600300	O-RING (WATER PUMP)	1	▪	▪	▪	0770160030
A820010014100	WASHER (WATER PUMP)	2	▪	▪	▪	0603100141
P025000005365	CLUTCH SLAVE GASKET	1	▪	▪	▪	50332065053
P003000005362	CRANKCASE GASKET	1	▪	▪	▪	50330039000
P016000005505	IGNITION COVER GASKET	1	▪	▪	▪	50330040100
X520002500200	O-RING (CRANKSHAFT GEAR)	1	▪	▪	▪	0770250020
X520002300200	O-RING (CRANKSHAFT GEAR)	1	▪	▪	▪	0770230020
X520001600300	O-RING (OIL FILLER CAP)	1	▪	▪	▪	0770160030



P02D000005356 | 50330035025 (0,25 mm)
 P02F000005356 | 50330035040 (0,4 mm)
 P02G000005356 | 50330035050 (0,5 mm)
 P02I000005356 | 50330035075 (0,8 mm) **K S I**

CYLINDER BASE GASKET

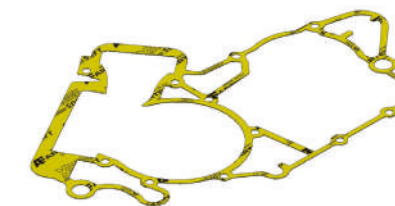

P003000005362 | 50330039000 **I**

CRANKCASE GASKET

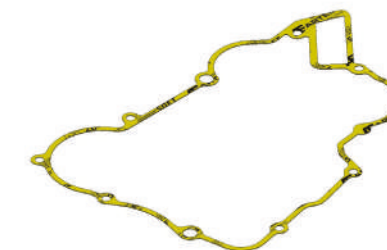

P018000005363 | 50330025000 **S I**

CLUTCH COVER GASKET



P025000005364 | 50330027000 **S I**

FRICTION DISC COVER GASKET



P016000005505 | 50330040100 **I**

IGNITION COVER GASKET



P025000005361 | 50337035050 **K S I**

EXHAUST VALVE GASKET, LEVER



P025000005359 | 50337006100 **K S I**

EXHAUST VALVE GASKET, RIGHT SIDE



P025000005360 | 50337008100 **K S I**

EXHAUST VALVE GASKET, LEFT SIDE



P025000005357 | 50337046300 **K S I**

EXHAUST VALVE GASKET, FRONT SIDE

ARTEIN PART No.	DESCRIPTION	UNITS	TOP END KIT K0000KT0K0869	SMART KIT S0000KT0S0869	COMPLETE SET J0000KT000869	ORIGINAL PART No.
X520008900200	O-RING (CYLINDER HEAD GASKET, OUTER)	1	▪	▪	▪	0770600200
X560006000200	O-RING (CYLINDER HEAD GASKET, INNER) (125 CC)	1	▪	▪	▪	0770600200
X560006400200	O-RING (CYLINDER HEAD GASKET, INNER) (150 CC)	1	▪	▪	▪	0770640200
X520002300250	O-RING (CYLINDER HEAD GASKET, UPPER)	1	▪	▪	▪	07702300251
A820007012100	WASHER (CYLINDER HEAD)	6	▪	▪	▪	0603070121
A820006010100	WASHER (CYLINDER HEAD)	1	▪	▪	▪	0603061001
P02D000005552	CYLINDER BASE GASKET (0,25 MM)	1	▪	▪	▪	50430035025
P02F000005552	CYLINDER BASE GASKET (0,4 MM)	1	▪	▪	▪	50430035040
P02G000005552	CYLINDER BASE GASKET (0,5 MM)	1	▪	▪	▪	50430035050
P02I000005552	CYLINDER BASE GASKET (0,8 MM)	1	▪	▪	▪	50430035075
X560003800300	O-RING (EXHAUST PIPE)	2	▪	▪	▪	0770380030
P025000005555	EXHAUST VALVE COVER GASKET, RIGHT SIDE	1	▪	▪	▪	50437008100
P025000005554	EXHAUST VALVE COVER GASKET, LEFT SIDE	1	▪	▪	▪	50437006100
P025000005553	EXHAUST VALVE COVER GASKET, FRONT SIDE	1	▪	▪	▪	50437046000
P015000005523	REED VALVE GASKET	1	▪	▪	▪	50430098050
P029000005524	INTAKE GASKET	1	▪	▪	▪	50430098060
X560001400200	O-RING (EXHAUST VALVE)	4	▪	▪	▪	0770140201
X520001237262	O-RING (EXHAUST VALVE)	1	▪	▪	▪	0770021120
A820006010100	WASHER (EXHAUST VALVE)	1	▪	▪	▪	0603061001
X520002400200	O-RING (CENTRIFUGAL COVER)	1	▪	▪	▪	0770240020
A820012018150	WASHER (OIL DRAIN)	1	▪	▪	▪	58038022000
A820006010100	WASHER (CLUTCH COVER)	1	▪	▪	▪	0603061001
P025000005558	FRICTION DISC COVER GASKET	1	▪	▪	▪	50430027000
A820010014100	WASHER (CLUTCH COVER)	1	▪	▪	▪	0603100141
P018000005557	CLUTCH COVER GASKET	1	▪	▪	▪	50430025000
P014000005559	WATER PUMP COVER GASKET	1	▪	▪	▪	50435053000
A820006010100	WASHER (WATER PUMP)	1	▪	▪	▪	0603061001
P003000005556	CRANKCASE GASKET	1	▪	▪	▪	50430039000
X520003000150	O-RING (CLUTCH SLAVE)	1	▪	▪	▪	0770300015
X520002300200	O-RING (FRONT SPROCKET)	1	▪	▪	▪	0770230020
X520002500200	O-RING (CRANKSHAFT GEAR)	1	▪	▪	▪	0770250020
X520001900300	O-RING (OIL FILLER CAP)	1	▪	▪	▪	0770191015



P02D000005552 | 50430035025 (0,25 mm)
P02F000005552 | 50430035040 (0,4 mm)
P02G000005552 | 50430035050 (0,5 mm)
P02I000005552 | 50430035075 (0,8 mm)

CYLINDER BASE GASKET

K S J

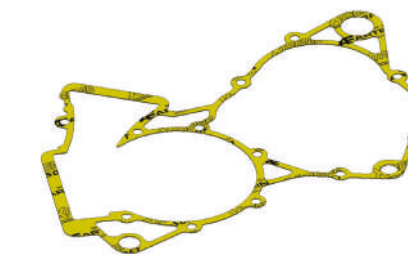

P003000005556 | 50430039000

CRANKCASE GASKET

J



P014000005559 | 50435053000

WATER PUMP COVER GASKET

S J



P015000005523 | 50430098050

REED VALVE GASKET

K S J

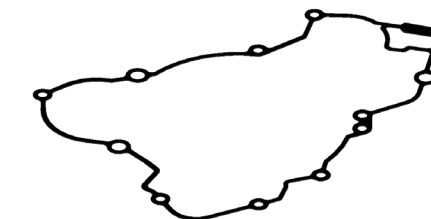

P018000005557 | 50430025000

CLUTCH COVER GASKET

S J



P025000005553 | 50437046000

EXHAUST VALVE GASKET, FRONT SIDE

K S J



P025000005554 | 50437006100

EXHAUST VALVE GASKET, LEFT SIDE

K S J

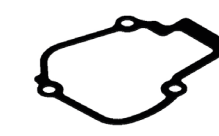

P025000005555 | 50437008100

EXHAUST VALVE GASKET, RIGHT SIDE

K S J



P029000005524 | 50430098060

INTAKE GASKET

K S J

ARTEIN PART No.	DESCRIPTION	UNITS	TOP END KIT K0000KT0K0879	SMART KIT S0000KT0S0879	COMPLETE SET J0000KT000879	ORIGINAL PART No.
X520008900200	O-RING (CYLINDER HEAD GASKET, OUTER)	1	▪	▪	▪	0770600200
X560006000200	O-RING (CYLINDER HEAD GASKET, INNER) (125 CC)	1	▪	▪	▪	0770600200
X520002300250	O-RING (CYLINDER HEAD GASKET, UPPER)	1	▪	▪	▪	07702300251
P02D000005615	CYLINDER BASE GASKET (0,25 MM)	1	▪	▪	▪	A42030035025
P02E000005615	CYLINDER BASE GASKET (0,3 MM)	1	▪	▪	▪	A42030035030
P02F000005615	CYLINDER BASE GASKET (0,4 MM)	1	▪	▪	▪	A42030035040
P02G000005615	CYLINDER BASE GASKET (0,5 MM)	1	▪	▪	▪	A42030035050
A820007012100	WASHER (CYLINDER HEAD)	6	▪	▪	▪	0603070121
A820006010100	WASHER (CYLINDER HEAD)	1	▪	▪	▪	0603061001
X560003800300	O-RING (EXHAUST PIPE)	2	▪	▪	▪	0770380030
P025000005614	EXHAUST VALVE COVER GASKET	2	▪	▪	▪	A42037006000
X560Q02189262	Q-RING (EXHAUST VALVE COVER GASKET)	1	▪	▪	▪	0770002226200
P015000005523	REED VALVE GASKET	1	▪	▪	▪	50430098050
P029000005524	INTAKE GASKET	1	▪	▪	▪	50430098060
X560001400200	O-RING (EXHAUST VALVE)	2	▪	▪	▪	0770140201
X560001200150	O-RING (EXHAUST VALVE)	2	▪	▪	▪	07700120151
A820012018150	WASHER (OIL DRAIN)	1	▪	▪	▪	58038022000
A820006010100	WASHER (CLUTCH COVER)	1	▪	▪	▪	0603061001
P018000005616	CLUTCH COVER GASKET	1	▪	▪	▪	A42030025000
P025000005617	FRICTION DISC COVER GASKET	1	▪	▪	▪	A42030027000
P014000005619	WATER PUMP COVER GASKET	1	▪	▪	▪	A44035052010
A820006010100	WASHER (WATER PUMP)	1	▪	▪	▪	0603061001
X551001000200	O-RING (WATER SENSOR TEMP)	1	▪	▪	▪	0770100020
X520002195178	O-RING (TPS COVER)	1	▪	▪	▪	75041077110
X560000750350	O-RING (FUEL INJECTOR)	2	▪	▪	▪	55641023020
X560000800300	O-RING (FUEL INJECTOR)	2	▪	▪	▪	55641023010
X520003000150	O-RING (CLUTCH SLAVE)	1	▪	▪	▪	0770300015
X520002512178	O-RING (FRONT SPROCKET)	1	▪	▪	▪	0770020220
P016000005618	IGNITION COVER GASKET	1	▪	▪	▪	A42030040000
X520002500200	O-RING (CRANKSHAFT GEAR)	1	▪	▪	▪	0770250020
X520001900300	O-RING (OIL FILLER CAP)	1	▪	▪	▪	0770191015



P02D000005615 | A42030035025 (0,25 mm)
P02E000005615 | A42030035030 (0,3 mm)
P02F000005615 | A42030035040 (0,4 mm)
P02G000005615 | A42030035050 (0,5 mm) **K S J**

CYLINDER BASE GASKET

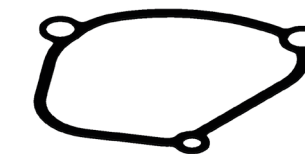

P025000005614 | A42037006000 **K S J**

EXHAUST VALVE COVER GASKET



P015000005523 | 50430098050 **K S J**

REED VALVE GASKET



P029000005524 | 50430098060 **K S J**

INTAKE GASKET

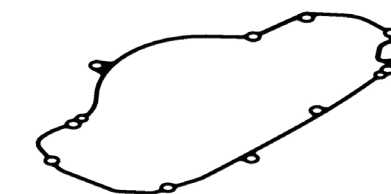

P018000005616 | A42030025000 **S J**

CLUTCH COVER GASKET

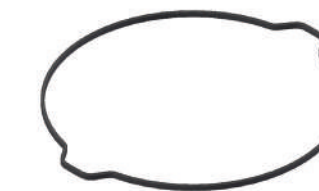

P025000005617 | A42030027000 **S J**

FRICTION DISC COVER GASKET

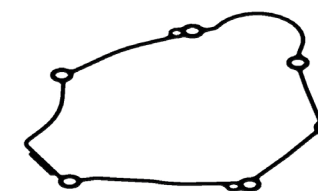

P016000005618 | A42030040000 **J**

IGNITION COVER GASKET



P014000005619 | A44035052010 **S J**

WATER PUMP COVER GASKET

ARTEIN PART No.	DESCRIPTION	UNITS	TOP END KIT K0000KT0K0805	SMART KIT S0000KT0S0805	COMPLETE SET J0000KT000805	ORIGINAL PART No.
X560007300200	O-RING (CYLINDER HEAD GASKET, INNER) (250 CC)	1	▪	▪	▪	0770730020
X560007800200	O-RING (CYLINDER HEAD GASKET, INNER) (300 CC)	1	▪	▪	▪	0770078020
X560010500200	O-RING (CYLINDER HEAD GASKET, OUTER)	1	▪	▪	▪	0770105020
P02D000005045	CYLINDER BASE GASKET (0,25 MM)	1	▪	▪	▪	54830030002
P02F000005045	CYLINDER BASE GASKET (0,4 MM)	1	▪	▪	▪	54830030004
P02G000005045	CYLINDER BASE GASKET (0,5 MM)	1	▪	▪	▪	54830030005
P02I000005045	CYLINDER BASE GASKET (0,8 MM)	1	▪	▪	▪	54830030075
P012000005046	EXHAUST GASKET	1	▪	▪	▪	72536041000
P025010005051	EXHAUST VALVE COVER GASKET, LEFT SIDE	1	▪	▪	▪	55537006000
P008000005621	EXHAUST VALVE COVER GASKET, RIGHT SIDE	1	▪	▪	▪	55537008000
X560004400300	O-RING (EXHAUST PIPE)	2	▪	▪	▪	0770440030
A820008016150	WASHER (CYLINDER HEAD)	6	▪	▪	▪	56530080000
P015000005047	REED VALVE GASKET	1	▪	▪	▪	54830062200
X560001600200	O-RING (EXHAUST VALVE)	2	▪	▪	▪	0770160021
X560001500150	O-RING (EXHAUST VALVE)	2	▪	▪	▪	0770150151
P018000005042	CLUTCH COVER GASKET	1	▪	▪	▪	54830024100
P025000005043	FRICTION DISC COVER GASKET	1	▪	▪	▪	55130027000
X551001130240	O-RING (WATER HOSE SEAL)	4	▪	▪	▪	0770116241
A820012018150	WASHER (OIL DRAIN)	1	▪	▪	▪	58038022000
A820010014100	WASHER (WATER PUMP)	1	▪	▪	▪	0603100141
P014000005044	WATER PUMP COVER GASKET	1	▪	▪	▪	54835003000
P016000005605	IGNITION COVER GASKET (SX/XC/XC-W)	1	▪	▪	▪	54830040000
P016000005048	IGNITION COVER GASKET	1	▪	▪	▪	55130040100
P025000005049	ELECTRIC START COVER GASKET	1	▪	▪	▪	55130041100
X520002480220	O-RING (FRONT SPROCKET)	1	▪	▪	▪	0770248022
X520002500300	O-RING (ELECTRIC START)	1	▪	▪	▪	0770250030
X520002500150	O-RING (PRIMARY GEAR)	1	▪	▪	▪	0770250015
X520001900300	O-RING (OIL FILLER CAP)	1	▪	▪	▪	0770191015
P003000005041	CRANKCASE GASKET	1	▪	▪	▪	54830039000
X520002400200	O-RING (CENTRIFUGAL COVER)	1	▪	▪	▪	0770240020
X520003000150	O-RING (CLUTCH SLAVE)	1	▪	▪	▪	0770300015
X520003147178	O-RING (CLUTCH SLAVE)	1	▪	▪	▪	0770031018
X520002500200	O-RING (FRONT SPROCKET)	1	▪	▪	▪	0770250020
A820006010100	WASHER (CLUTCH COVER)	1	▪	▪	▪	0603061001



P02D000005045 | 54830030002 (0,25 mm)
 P02F000005045 | 54830030004 (0,4 mm)
 P02G000005045 | 54830030005 (0,5 mm)
 P02I000005045 | 54830030075 (0,8 mm)

CYLINDER BASE GASKET



P025000005049 | 55130041100

ELECTRIC START COVER GASKET

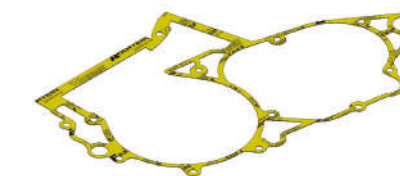

P003000005041 | 54830039000

CRANKCASE GASKET



P018000005042 | 54830024100

CLUTCH COVER GASKET

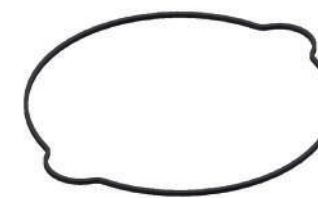

P025000005043 | 55130027000

FRICTION DISC COVER GASKET

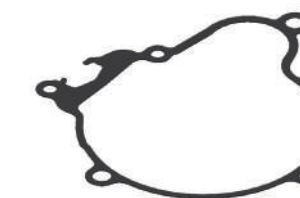

P016000005605 | 54830040000
 P016000005048 | 55130040100

IGNITION COVER GASKET

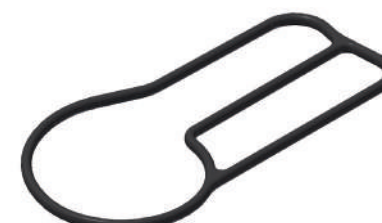

P014000005044 | 54835003000

WATER PUMP COVER GASKET



P008000005621 | 55537008000

EXHAUST VALVE COVER GASKET, RIGHT SIDE



P025010005051 | 55537006000

EXHAUST VALVE COVER GASKET, LEFT SIDE

ARTEIN PART No.	DESCRIPTION	UNITS	TOP END KIT K0000KT0K0806	SMART KIT S0000KT0S0806	COMPLETE SET J0000KT000806	ORIGINAL PART No.
P001000005060	CYLINDER HEAD GASKET	1	▪	▪	▪	77030036000
P02G000005056	CYLINDER BASE GASKET (0,5 MM)	1	▪	▪	▪	77030035200
P012000005061	EXHAUST GASKET	1	▪	▪	▪	77036041000
X520001800200	O-RING (DISTRIBUTION TENSIONER)	1	▪	▪	▪	0770180020
A820024030150	WASHER (DISTRIBUTION TENSIONER)	1	▪	▪	▪	0603242920
X520001000100	O-RING (DISTRIBUTION TENSIONER)	1	▪	▪	▪	0770010010
KRV00KT0V0806	VALVE STEM SEALS KIT	1	▪	▪	▪	-
A820012018150	WASHER (OIL DRAIN)	2	▪	▪	▪	58038022000
P018000005054	CLUTCH COVER GASKET	1	▪	▪	▪	77030025100
P025000005055	FRICTION DISC COVER GASKET	1	▪	▪	▪	77030027000
A820006010100	WASHER (CLUTCH COVER)	1	▪	▪	▪	0603061001
X520001200200	O-RING (OIL DRAIN)	1	▪	▪	▪	0770120020
A820008014200	WASHER (OIL DRAIN)	1	▪	▪	▪	58030081000
P014000005058	WATER PUMP COVER GASKET	1	▪	▪	▪	77035053000
A820006010100	WASHER (WATER PUMP)	1	▪	▪	▪	0603061001
P016000005062	IGNITION COVER GASKET	1	▪	▪	▪	77030140000
P016000005606	IGNITION COVER GASKET (SX-F/SXS-F)	1	▪	▪	▪	77030040000
P025000005057	CLUTCH SLAVE GASKET	1	▪	▪	▪	59032065000
X520003000150	O-RING (CLUTCH SLAVE)	1	▪	▪	▪	0770300015
X520001250150	O-RING (OIL FILTER)	2	▪	▪	▪	0770125015
X520001717178	O-RING (OIL FILTER)	1	▪	▪	▪	0770020170
X520004000250	O-RING (OIL FILTER)	1	▪	▪	▪	0770400025
X520003200200	O-RING (OIL PUMP)	1	▪	▪	▪	0770320020
X520002300200	O-RING (FRONT SPROCKET)	1	▪	▪	▪	0770230020
X520002512178	O-RING (FRONT SPROCKET)	1	▪	▪	▪	0770020220
A820006010100	WASHER (IGNITION COVER)	1	▪	▪	▪	0603061001
X520001900300	O-RING (OIL FILLER CAP)	1	▪	▪	▪	0770191015

RELATED PRODUCTS

ARTEIN PART No.	DESCRIPTION
KRV00KT0V0806	VALVE STEM SEALS KIT

XRADICAL
SUPER GASKETS



▲ P02G000005056 | 77030035200 **K S J**
CYLINDER BASE GASKET



▲ P001000005060 | 77030036000 **K S J**
CYLINDER HEAD GASKET



▲ P012000005061 | 77036041000 **K S J**
EXHAUST GASKET



▲ P018000005054 | 77030025100 **S J**
CLUTCH COVER GASKET



▲ P025000005055 | 77030027000 **S J**
FRICTION DISC COVER GASKET

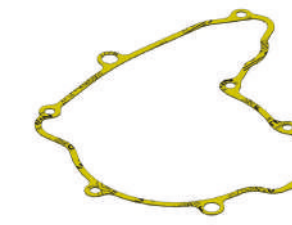

▲ P016000005062 | 77030140000 **J**
IGNITION COVER GASKET



▲ P016000005606 | 77030040000 **J**
IGNITION COVER GASKET



▲ P014000005058 | 77035053000 **S J**
WATER PUMP COVER GASKET



▲ P025000005057 | 59032065000 **J**
SLAVE CLUTCH GASKET

ARTEIN PART No.	DESCRIPTION	UNITS	TOP END KIT K0000KT0K0867	SMART KIT S0000KT0S0867	COMPLETE SET J0000KT000867	ORIGINAL PART No.
X560007300200	O-RING (CYLINDER HEAD GASKET, INNER) (250 CC)	1	▪	▪	▪	0770730020
X560007800200	O-RING (CYLINDER HEAD GASKET, INNER) (300 CC)	1	▪	▪	▪	0770780020
X560010500200	O-RING (CYLINDER HEAD GASKET, OUTER)	1	▪	▪	▪	0770105020
P02D000005522	CYLINDER BASE GASKET (0,25 MM)	1	▪	▪	▪	55430030025
P02F000005522	CYLINDER BASE GASKET (0,4 MM)	1	▪	▪	▪	55430030040
P02G000005522	CYLINDER BASE GASKET (0,5 MM)	1	▪	▪	▪	55430030050
P02I000005522	CYLINDER BASE GASKET (0,8 MM)	1	▪	▪	▪	55430030075
A820008016150	WASHER (CYLINDER HEAD)	6	▪	▪	▪	56530080000
A820006010100	WASHER (CYLINDER HEAD)	1	▪	▪	▪	0603061001
P025010005051	EXHAUST VALVE COVER GASKET, LEFT SIDE	1	▪	▪	▪	55537006000
P008000005621	EXHAUST VALVE COVER GASKET, RIGHT SIDE	1	▪	▪	▪	55537008000
X560004400300	O-RING (EXHAUST PIPE)	2	▪	▪	▪	0770440030
X551001130240	O-RING (EXHAUST COVER VALVE, FRONT SIDE)	4	▪	▪	▪	0770116241
P015000005523	REED VALVE GASKET	1	▪	▪	▪	50430098050
P029000005524	INTAKE GASKET	1	▪	▪	▪	50430098060
X560001600200	O-RING (EXHAUST VALVE)	2	▪	▪	▪	0770160021
X560001500150	O-RING (EXHAUST VALVE)	2	▪	▪	▪	0770150151
X520001237262	O-RING (EXHAUST VALVE)	1	▪	▪	▪	0770021120
X520002400200	O-RING (EXHAUST VALVE)	1	▪	▪	▪	0770240020
A820012018150	WASHER (OIL DRAIN)	1	▪	▪	▪	58038022000
P018000005525	CLUTCH COVER GASKET	1	▪	▪	▪	55430025100
P025000005526	FRICTION DISC COVER GASKET	1	▪	▪	▪	55430027000
P014000005528	WATER PUMP COVER GASKET	1	▪	▪	▪	55435053000
A820006010100	WASHER (WATER PUMP)	1	▪	▪	▪	0603061001
X560000800300	O-RING (FUEL INJECTOR)	2	▪	▪	▪	55641023010
X560000750350	O-RING (FUEL INJECTOR)	2	▪	▪	▪	55641023020
P003000005527	CRANKCASE GASKET	1	▪	▪	▪	55430039000
X520002500150	O-RING (PRIMARY GEAR)	1	▪	▪	▪	0770250015
X520003000150	O-RING (CLUTCH SLAVE)	1	▪	▪	▪	0770300015
X520002512178	O-RING (FRONT SPROCKET)	1	▪	▪	▪	0770020220
X520003200200	O-RING (THERMOSTAT COVER)	1	▪	▪	▪	0770320020
P016000005529	IGNITION COVER GASKET	1	▪	▪	▪	55430040100
X520001900300	O-RING (OIL FILLER CAP)	1	▪	▪	▪	0770191015



P02G000005522 | 55430030025 (0,25 mm)
 P02F000005522 | 55430030040 (0,4 mm)
 P02G000005522 | 55430030050 (0,5 mm)
 P02I000005522 | 55430030075 (0,8 mm) **K S J**

CYLINDER BASE GASKET



P015000005523 | 50430098050 **K S J**

REED VALVE GASKET



P029000005524 | 50430098060 **K S J**

INTAKE GASKET



P003000005527 | 55430039000 **J**

CRANKCASE GASKET

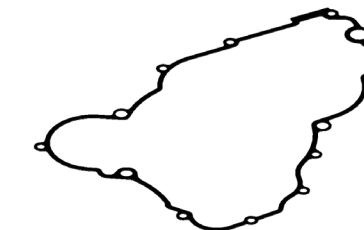

P018000005525 | 55430025100 **S J**

CLUTCH COVER GASKET

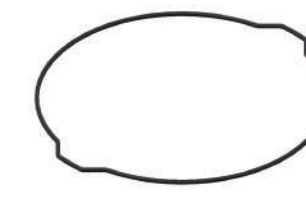

P025000005526 | 55430027000 **S J**

FRICTION DISC COVER GASKET

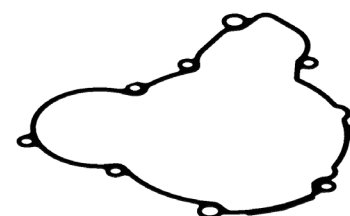

P016000005529 | 55430040100 **J**

IGNITION COVER GASKET



P008000005621 | 54557008000 **K S J**

EXHAUST VALVE GASKET, RIGHT SIDE

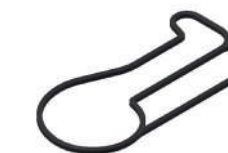

P014000005528 | 55435053000 **S J**

WATER PUMP COVER GASKET

ARTEIN PART No.	DESCRIPTION	UNITS	TOP END KIT K0000KT0K0867	SMART KIT S0000KT0S0880	COMPLETE SET J0000KT000880	ORIGINAL PART No.
X560007300200	O-RING (CYLINDER HEAD GASKET, INNER) (250 CC)	1	▪	▪	▪	0770730020
X560007800200	O-RING (CYLINDER HEAD GASKET, INNER) (300 CC)	1	▪	▪	▪	0770780020
X560010500200	O-RING (CYLINDER HEAD GASKET, OUTER)	1	▪	▪	▪	0770105020
P02D000005522	CYLINDER BASE GASKET (0,25 MM)	1	▪	▪	▪	55430030025
P02F000005522	CYLINDER BASE GASKET (0,4 MM)	1	▪	▪	▪	55430030040
P02G000005522	CYLINDER BASE GASKET (0,5 MM)	1	▪	▪	▪	55430030050
P02I000005522	CYLINDER BASE GASKET (0,8 MM)	1	▪	▪	▪	55430030075
A820008016150	WASHER (CYLINDER HEAD)	6	▪	▪	▪	56530080000
A820006010100	WASHER (CYLINDER HEAD)	1	▪	▪	▪	0603061001
P025010005051	EXHAUST VALVE COVER GASKET, LEFT SIDE	1	▪	▪	▪	55537006000
P008000005621	EXHAUST VALVE COVER GASKET, RIGHT SIDE	1	▪	▪	▪	55537008000
X560004400300	O-RING (EXHAUST PIPE)	2	▪	▪	▪	0770440030
X551001130240	O-RING (EXHAUST COVER VALVE, FRONT SIDE)	4	▪	▪	▪	0770116241
P015000005523	REED VALVE GASKET	1	▪	▪	▪	50430098050
P029000005524	INTAKE GASKET	1	▪	▪	▪	50430098060
X560001600200	O-RING (EXHAUST VALVE)	2	▪	▪	▪	0770160021
X560001500150	O-RING (EXHAUST VALVE)	2	▪	▪	▪	0770150151
X520001237262	O-RING (EXHAUST VALVE)	1	▪	▪	▪	0770021120
X520002400200	O-RING (EXHAUST VALVE)	1	▪	▪	▪	0770240020
A820012018150	WASHER (OIL DRAIN)	1	▪	▪	▪	58038022000
P018000005525	CLUTCH COVER GASKET	1	▪	▪	▪	55430025100
P025000005526	FRICTION DISC COVER GASKET	1	▪	▪	▪	55430027000
P014000005620	WATER PUMP GASKET	1	▪	▪	▪	55535053100
A820006010100	WASHER (WATER PUMP)	1	▪	▪	▪	0603061001
X560000800300	O-RING (FUEL INJECTOR)	2	▪	▪	▪	55641023010
X560000750350	O-RING (FUEL INJECTOR)	2	▪	▪	▪	55641023020
P003000005527	CRANKCASE GASKET	1	▪	▪	▪	55430039000
X520002500150	O-RING (PRIMARY GEAR)	1	▪	▪	▪	0770250015
X520003000150	O-RING (CLUTCH SLAVE)	1	▪	▪	▪	0770300015
X520002512178	O-RING (FRONT SPROCKET)	1	▪	▪	▪	0770020220
X520003200200	O-RING (THERMOSTAT COVER)	1	▪	▪	▪	0770320020
P016000005529	IGNITION COVER GASKET	1	▪	▪	▪	55430040100
X520001900300	O-RING (OIL FILLER CAP)	1	▪	▪	▪	0770191015



P02G000005522 | 55430030025 (0,25 mm)
 P02F000005522 | 55430030040 (0,4 mm)
 P02G000005522 | 55430030050 (0,5 mm)
 P02I000005522 | 55430030075 (0,8 mm) **K S J**

CYLINDER BASE GASKET



P025010005051 | 55537006000 **K S J**

EXHAUST VALVE COVER GASKET, LEFT SIDE



P008000005621 | 54557008000 **K S J**

EXHAUST VALVE COVER GASKET, RIGHT SIDE



P015000005523 | 50430098050 **K S J**

REED VALVE GASKET



P003000005527 | 55430039000 **J**

CRANKCASE GASKET

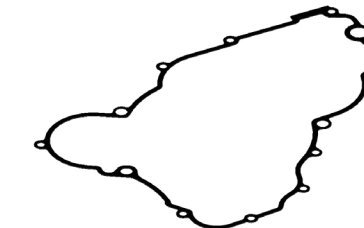

P018000005525 | 55430025100 **S J**

CLUTCH COVER GASKET

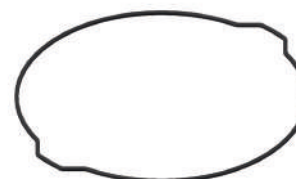

P025000005526 | 55430027000 **S J**

FRICTION DISC COVER GASKET

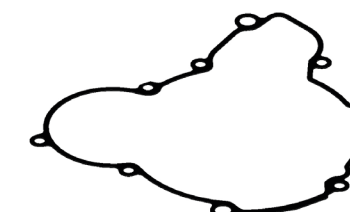

P016000005529 | 55430040100 **J**

IGNITION COVER GASKET



P014000005620 | 55535053100 **S J**

WATER PUMP GASKET

ARTEIN PART No.	DESCRIPTION	UNITS	TOP END KIT K0000KT0K0807	SMART KIT S0000KT0S0807	COMPLETE SET J0000KT000807	ORIGINAL PART No.
P001000005069	CYLINDER HEAD GASKET	1	▪	▪	▪	77230036000
P02F000005065	CYLINDER BASE GASKET (0,4 MM)	1	▪	▪	▪	77230035000
P012000005070	EXHAUST GASKET	1	▪	▪	▪	77236041000
X520001000100	O-RING (DISTRIBUTION TENSIONER)	1	▪	▪	▪	0770010010
A820024030150	WASHER (DISTRIBUTION TENSIONER)	1	▪	▪	▪	0603242920
X520001800200	O-RING (DISTRIBUTION TENSIONER)	1	▪	▪	▪	0770180020
X520002600150	O-RING (SPARK PLUG)	2	▪	▪	▪	07702600151
KRV00KT0V0807	VALVE STEM SEALS KIT	1	▪	▪	▪	-
X520000900150	O-RING (CYLINDER HEAD)	2	▪	▪	▪	0770090015
P018000005063	CLUTCH COVER GASKET	1	▪	▪	▪	77230025000
P025000005064	FRICTION DISC COVER GASKET	1	▪	▪	▪	77230027000
A820012018150	WASHER (OIL DRAIN)	2	▪	▪	▪	58038022000
X520001400200	O-RING (CLUTCH COVER)	1	▪	▪	▪	0770140200
X551001100150	O-RING (OIL DRAIN)	1	▪	▪	▪	0770110015
A820008014200	WASHER (OIL DRAIN)	1	▪	▪	▪	58030081000
A820006010100	WASHER (WATER PUMP)	1	▪	▪	▪	0603061001
P014000005067	WATER PUMP COVER GASKET	1	▪	▪	▪	77235053000
P016000005072	IGNITION COVER GASKET, INNER	1	▪	▪	▪	77530040000
P016000005071	IGNITION COVER GASKET, OUTER	1	▪	▪	▪	77530042000
P031000005076	ELECTRIC START COVER GASKET	1	▪	▪	▪	77240043000
X520003000150	O-RING (CLUTCH SLAVE)	1	▪	▪	▪	0770300015
X560002400250	O-RING (INGNITION COVER)	1	▪	▪	▪	7700240251
X520001250150	O-RING (OIL SCREEN)	2	▪	▪	▪	0770125015
X520000900150	O-RING (BALANCER SHAFT)	2	▪	▪	▪	7700900151
X520001717178	O-RING (OIL SCREEN)	1	▪	▪	▪	0770020170
X520003305178	O-RING (OIL FILTER)	1	▪	▪	▪	7703305178
X560004400200	O-RING (OIL PUMP)	1	▪	▪	▪	0770440020
X520002512178	O-RING (FRONT SPROCKET)	1	▪	▪	▪	0770020220
X551001000200	O-RING (WATER SENSOR TEMP)	1	▪	▪	▪	0770100020
P025000005066	CLUTCH SLAVE GASKET	1	▪	▪	▪	77232062000
X520001900300	O-RING (OIL FILLER CAP)	1	▪	▪	▪	0770191015

RELATED PRODUCTS	
ARTEIN PART No.	DESCRIPTION
KRV00KT0V0807	VALVE STEM SEALS KIT



▲ P02F000005065 | 77230035000 **K S J**
CYLINDER BASE GASKET



▲ P001000005069 | 77230036000 **K S J**
CYLINDER HEAD GASKET



▲ P012000005070 | 77236041000 **K S J**
EXHAUST GASKET



▲ P018000005063 | 77230025000 **S J**
CLUTCH COVER GASKET

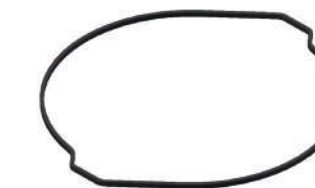

▲ P025000005064 | 77230027000 **S J**
FRICTION DISC COVER GASKET

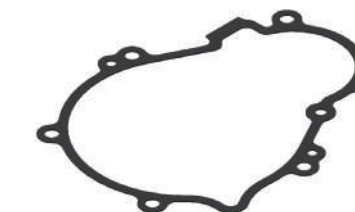

▲ P016000005072 | 77530040000 **J**
IGNITION COVER GASKET, INNER



▲ P016000005071 | 77530042000 **J**
IGNITION COVER GASKET, OUTER



▲ P014000005067 | 77235053000 **J**
WATER PUMP COVER GASKET



▲ P031000005076 | 77240043000 **J**
ELECTRIC START COVER GASKET

ARTEIN PART No.	DESCRIPTION	UNITS	TOP END KIT K0000KT0K0808	SMART KIT S0000KT0S0808	COMPLETE SET J0000KT000808	ORIGINAL PART No.
P001000005086	CYLINDER HEAD GASKET	1	•	•	•	77330036000
X560010770178	O-RING (CYLINDER BASE GASKET)	2	•	•	•	0770108018
P012000005087	EXHAUST GASKET	1	•	•	•	77336041000
P025000005083	GEAR CASE COVER GASKET	1	•	•	•	77330035000
KRV00KT0V0808	VALVE STEM SEALS KIT	1	•	•	•	-
X520001000100	O-RING (DISTRIBUTION TENSIONER)	1	•	•	•	0770010010
A820024030150	WASHER (DISTRIBUTION TENSIONER)	1	•	•	•	0603242920
X520001800200	O-RING (DISTRIBUTION TENSIONER)	1	•	•	•	0770180020
X520002500150	O-RING (CAMSHAFT HOLDER)	1	•	•	•	0770250015
X520000600150	O-RING (CAMSHAFT HOLDER)	2	•	•	•	0770060015
X520001500178	O-RING (CYLINDER HEAD)	2	•	•	•	0770015018
X520001200150	O-RING (CYLINDER HEAD)	2	•	•	•	0770012015
X520000900150	O-RING (CYLINDER HEAD)	2	•	•	•	0770090015
P025000005082	FRICTION DISC COVER GASKET	1	•	•	•	77330027000
A820012018150	WASHER (OIL DRAIN)	1	•	•	•	58038022000
X520000800150	O-RING (CLUTCH COVER)	1	•	•	•	0770080015
A820008012100	WASHER (OIL DRAIN)	1	•	•	•	0603082121
A820006010100	WASHER (WATER PUMP)	1	•	•	•	0603061001
P014000005084	WATER PUMP COVER GASKET	1	•	•	•	77335053000
X560Q02830178	Q-RING (WATER PUMP)	1	•	•	•	77335005000
P013000005088	OIL PUMP GASKET	1	•	•	•	77338012000
P013000005089	OIL PUMP GASKET	1	•	•	•	77338112000
P016000005090	IGNITION COVER GASKET	1	•	•	•	77330040100
X520003800200	O-RING (CLUTCH SLAVE)	1	•	•	•	0770380020
X520002200200	O-RING (IGNITION COVER)	1	•	•	•	0770220020
X520003934262	O-RING (OIL FILTER)	2	•	•	•	0770390261
X520002300150	O-RING (OIL FILTER)	2	•	•	•	0770023015
X560003000200	O-RING (OIL FILTER)	1	•	•	•	0770300020
X560003400150	O-RING (OIL FILTER)	1	•	•	•	0770034015
X520003305178	O-RING (OIL FILTER)	1	•	•	•	07703305178
X520002500150	O-RING (FRONT SPROCKET)	1	•	•	•	0770250015
A820014020150	WASHER (OIL PUMP)	1	•	•	•	0603142016
X520001900300	O-RING (OIL FILLER CAP)	1	•	•	•	0770191015

RELATED PRODUCTS

ARTEIN PART No.	DESCRIPTION
KRV00KT0V0808	VALVE STEM SEALS KIT



▲ P001000005086 | 77330036000 **K S J**
CYLINDER HEAD GASKET



▲ P025000005083 | 77330035000 **K S J**
GEAR CASE COVER GASKET



▲ P012000005087 | 77336041000 **K S J**
EXHAUST GASKET



▲ P016000005090 | 77330040100 **J**
IGNITION COVER GASKET

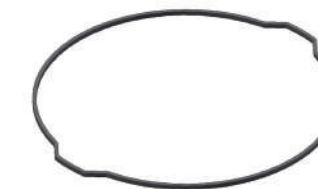

▲ P025000005082 | 77330027000 **S J**
FRICTION DISC COVER GASKET



▲ P014000005084 | 77335053000 **S J**
WATER PUMP COVER GASKET



▲ P013000005088 | 77338012000 **J**
OIL PUMP PRESSURE GASKET



▲ P013000005089 | 77338112000 **J**
OIL PUMP PRESSURE GASKET

ARTEIN PART No.	DESCRIPTION	UNITS	TOP END KIT K0000KT0K0809	SMART KIT S0000KT0S0809	COMPLETE SET J0000KT000809	ORIGINAL PART No.
P001000005079	CYLINDER HEAD GASKET	1	▪	▪	▪	78030036000
P02F000005075	CYLINDER BASE GASKET (0,4 MM)	1	▪	▪	▪	78030035000
P012000005080	EXHAUST GASKET	1	▪	▪	▪	78036041000
X520001000100	O-RING (DISTRIBUTION TENSIONER)	1	▪	▪	▪	0770010010
A820024030150	WASHER (DISTRIBUTION TENSIONER)	1	▪	▪	▪	0603242920
X520001800200	O-RING (DISTRIBUTION TENSIONER)	1	▪	▪	▪	0770180020
KRV00KT0V0809	VALVE STEM SEALS KIT	1	▪	▪	▪	-
A820006010100	WASHER (CYLINDER HEAD)	1	▪	▪	▪	0603061001
A820012018150	WASHER (CYLINDER HEAD)	1	▪	▪	▪	58038022000
X551001100150	O-RING (ROCKER ARM PLUG)	2	▪	▪	▪	0770110015
P025000005074	FRICITION DISC COVER GASKET	1	▪	▪	▪	78030027000
A820012018150	WASHER (CLUTCH COVER/OIL DRAIN)	2	▪	▪	▪	58038022000
A820006010100	WASHER (CLUTCH COVER)	1	▪	▪	▪	0603061001
P018000005073	CLUTCH COVER GASKET	1	▪	▪	▪	78030025000
P014000005077	WATER PUMP COVER GASKET	1	▪	▪	▪	78035053000
A820008014200	WASHER (OIL DRAIN)	1	▪	▪	▪	58030081000
A820006010100	WASHER (WATER PUMP)	1	▪	▪	▪	0603061001
X520000900150	O-RING (OIL SCREEN)	4	▪	▪	▪	0770090015
X520001250200	O-RING (OIL SCREEN)	2	▪	▪	▪	0770125020
X520003305178	O-RING (OIL FILTER)	1	▪	▪	▪	7703305178
X560003400150	O-RING (OIL FILTER)	1	▪	▪	▪	0770034015
P016000005081	IGNITION COVER GASKET	1	▪	▪	▪	78030040000
X560003200150	O-RING (OIL PUMP)	1	▪	▪	▪	0770320015
X560004400200	O-RING (OIL PUMP)	1	▪	▪	▪	0770440020
X520002512178	O-RING (FRONT SPROCKET)	1	▪	▪	▪	0770020220
X520001900300	O-RING (OIL FILLER CAP)	2	▪	▪	▪	0770191015
P025000005057	CLUTCH SLAVE GASKET	1	▪	▪	▪	59032065000
X520003000150	O-RING (CLUTCH SLAVE)	1	▪	▪	▪	0770300015

RELATED PRODUCTS

ARTEIN PART No.	DESCRIPTION
KRV00KT0V0809	VALVE STEM SEALS KIT

XRADICAL
SUPER GASKETS

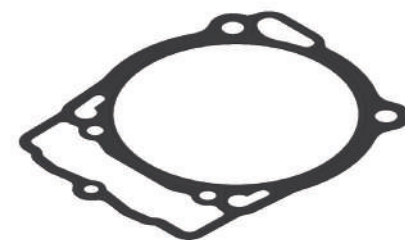

▲ P02F000005075 | 78030035000 **K S J**
CYLINDER BASE GASKET



▲ P001000005079 | 78030036000 **K S J**
CYLINDER HEAD GASKET



▲ P012000005080 | 78036041000 **K S J**
EXHAUST GASKET



▲ P018000005073 | 78030025000 **S J**
CLUTCH COVER GASKET

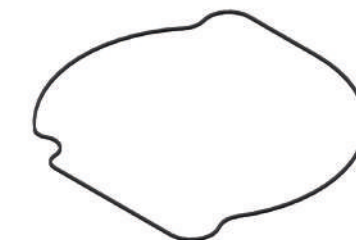

▲ P025000005074 | 78030027000 **S J**
FRICITION DISC COVER GASKET



▲ P016000005081 | 78030040000 **J**
IGNITION COVER GASKET



▲ P014000005077 | 78035053000 **S J**
WATER PUMP COVER GASKET



▲ P025000005057 | 59032065000 **J**
SLAVE CLUTCH GASKET

ARTEIN PART No.	DESCRIPTION	UNITS	TOP END KIT K0000KTOK0842	SMART KIT S0000KTOS0842	COMPLETE SET J0000KT000842	ORIGINAL PART No.
P001000005314	CYLINDER HEAD GASKET	1	▪	▪	▪	59530036000
X520001910160	O-RING (CYLINDER HEAD)	2	▪	▪	▪	0770191016
P02G000005315	CYLINDER BASE GASKET (0,5 MM)	1	▪	▪	▪	59030035050
P012000005319	EXHAUST GASKET	1	▪	▪	▪	59036041000
P010000005316	DISTRIBUTION TENSIONER GASKET	1	▪	▪	▪	59036003050
P008000005318	VALVE COVER GASKET, UPPER	2	▪	▪	▪	58036053000
A801006010200	WASHER (CYLINDER HEAD GASKET)	2	▪	▪	▪	59036060010
A820006010100	WASHER (CYLINDER HEAD GASKET)	11	▪	▪	▪	0603061001
A820007011200	WASHER (CYLINDER HEAD GASKET)	1	▪	▪	▪	58036065100
P014000005317	WATER PUMP COVER GASKET	1	▪	▪	▪	59035053000
KRV00KT0V0808	VALVE STEM SEALS KIT	1	▪	▪	▪	-
X520000900150	O-RING (CYLINDER HEAD)	2	▪	▪	▪	0770090015
P018000005321	CLUTCH COVER GASKET	1	▪	▪	▪	59030025200
P025000005504	FRICTION DISC COVER GASKET	1	▪	▪	▪	59030027000
A820012018150	WASHER (OIL DRAIN)	2	▪	▪	▪	58038022000
X520001200200	O-RING (OIL DRAIN)	1	▪	▪	▪	0770120020
A820008014200	WASHER (OIL DRAIN)	1	▪	▪	▪	58030081000
A820012018200	WASHER (OIL DRAIN)	1	▪	▪	▪	0603121830
P025000005057	CLUTCH SLAVE GASKET	1	▪	▪	▪	59032065000
P003000005320	CRANKCASE GASKET	1	▪	▪	▪	59030039200
P016000005322	IGNITION COVER GASKET	1	▪	▪	▪	59030040000
X520003000150	O-RING (CLUTCH SLAVE)	1	▪	▪	▪	0770300015
X520001250150	O-RING (OIL FILTER)	2	▪	▪	▪	0770125015
X520001717178	O-RING (OIL FILTER)	1	▪	▪	▪	0770020170
X520004000250	O-RING (OIL FILTER)	2	▪	▪	▪	0770440030
X520002512178	O-RING (FRONT SPROCKET)	1	▪	▪	▪	0770020220
X520001900300	O-RING (OIL FILLER CAP)	1	▪	▪	▪	0770191015

RELATED PRODUCTS

ARTEIN PART No.	DESCRIPTION
KRV00KT0V0808	VALVE STEM SEALS KIT

XRADICAL
SUPER GASKETS



▲ P02G000005315 | 59030035050 **K S J**
CYLINDER BASE GASKET



▲ P001000005314 | 59530036000 **K S J**
CYLINDER HEAD GASKET



▲ P012000005319 | 59036041000 **K S J**
EXHAUST GASKET

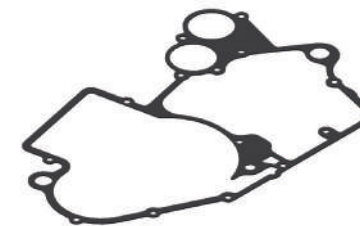

▲ P003000005320 | 59030039200 **J**
CRANKCASE GASKET



▲ P018000005321 | 59030025200 **S J**
CLUTCH COVER GASKET

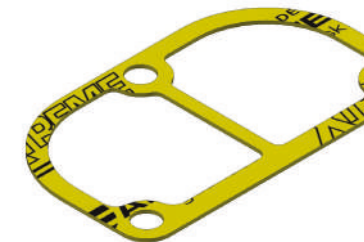

▲ P008000005318 | 58036053000 **K S J**
VALVE COVER GASKET
2 UNITS



▲ P016000005322 | 59030040000 **J**
IGNITION COVER GASKET



▲ P014000005317 | 59035053000 **K S J**
WATER PUMP COVER GASKET



▲ P010000005316 | 59036003050 **K S J**
DISTRIBUTION CHAIN TENSIONER GASKET

ARTEIN PART No.	DESCRIPTION	UNITS	TOP END KIT K0000SZ0K0876	SMART KIT S0000SZ0S0876	COMPLETE SET J0000SZ000876	ORIGINAL PART No.
X560005600200	O-RING (CYLINDER HEAD, INNER)	1	▪	▪	▪	11147-03B00-000
X520008862178	O-RING (CYLINDER HEAD, OUTER)	1	▪	▪	▪	11148-03B00-000
P02F000005589	CYLINDER BASE GASKET (0,4 MM)	1	▪	▪	▪	-
P02G000005589	CYLINDER BASE GASKET (0,5 MM)	1	▪	▪	▪	11241-03B00-000
A820008517200	WASHER (CYLINDER HEAD)	4	▪	▪	▪	09168-08021-000
P012000XR5264	EXHAUST GASKET	1	▪	▪	▪	14181-40C00-000
X560003600300	O-RING (EXHAUST GASKET)	1	▪	▪	▪	14171-03B00-000
P025000005591	EXHAUST VALVE COVER GASKET, RIGHT SIDE	1	▪	▪	▪	11233-02B42-000
P025000005590	EXHAUST VALVE COVER GASKET, FRONT SIDE	1	▪	▪	▪	11238-01B30-H17
X520001450200	O-RING (EXHAUST VALVE, LEFT SIDE)	1	▪	▪	▪	09280-15006-000
A820008014100	WASHER (OIL DRAIN)	1	▪	▪	▪	09168-08016-000
P018000005592	CLUTCH COVER GASKET	1	▪	▪	▪	11482-27C02-000
P014000005595	WATER PUMP COVER GASKET	1	▪	▪	▪	17431-02B42-000
A801006010100	WASHER (WATER PUMP)	1	▪	▪	▪	17413-28C10-000
A801006511150	WASHER (CLUTCH COVER)	1	▪	▪	▪	09168-06004-000
P016000005593	IGNITION COVER GASKET	1	▪	▪	▪	11483-03B00-000
P003000005594	CRANKCASE GASKET	1	▪	▪	▪	11481-03B00-000
X520001700300	O-RING (OIL FILLER CAP)	1	▪	▪	▪	09280-17003-000



P02F000005589 | - (0,4 mm)
P02G000005589 | 11241-03B00-000 (0,5 mm) **K S J**
CYLINDER BASE GASKET



P012000XR5264 | 14181-40C00-000 **K S J**
EXHAUST GASKET



P003000005594 | 11481-03B00-000 **J**
CRANKCASE GASKET

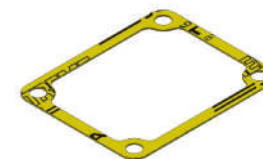

P025000005590 | 11238-01B30-H17 **K S J**
EXHAUST VALVE COVER GASKET, FRONT SIDE



P025000005591 | 11233-02B42-000 **K S J**
EXHAUST VALVE COVER GASKET, RIGHT SIDE

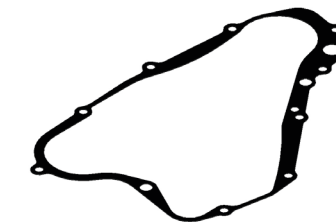

P018000005592 | 11482-27C02-000 **S J**
CLUTCH COVER GASKET



P014000005595 | 17431-02B42-000 **S J**
WATER PUMP COVER GASKET



P016000005593 | 11483-03B00-000 **J**
IGNITION COVER GASKET

XRADICAL
SUPER GASKETS

ARTEIN PART No.	DESCRIPTION	UNITS	TOP END KIT K0000SZ0K0877	SMART KIT S0000SZ0S0877	COMPLETE SET J0000SZ000877	ORIGINAL PART No.
X560006350182	O-RING (CYLINDER HEAD, INNER)	1	▪	▪	▪	11147-27C11-000
X520009030190	O-RING (CYLINDER HEAD, OUTER)	1	▪	▪	▪	11148-27C11-000
P02E000005735	CYLINDER BASE GASKET (0,30 MM) (2001-2006)	1	▪	▪	▪	-
P02F000005735	CYLINDER BASE GASKET (0,40 MM) (2001-2006)	1	▪	▪	▪	-
P02G000005735	CYLINDER BASE GASKET (0,50 MM) (2001-2006)	1	▪	▪	▪	11241-27C10-000
P02E000005601	CYLINDER BASE GASKET (0,30 MM) (2003-2012)	1	▪	▪	▪	-
P02F000005601	CYLINDER BASE GASKET (0,40 MM) (2003-2012)	1	▪	▪	▪	-
P02G000005601	CYLINDER BASE GASKET (0,50 MM) (2003-2012)	1	▪	▪	▪	11241-36F00-000
A820008517200	WASHER (CYLINDER HEAD)	5	▪	▪	▪	09168-08021-000
P008000005736	EXHAUST VALVE COVER GASKET, RIGHT SIDE	1	▪	▪	▪	11233-27C34-000
P012000005734	EXHAUST GASKET	1	▪	▪	▪	14171-36E00-000
P012000005602	EXHAUST GASKET	1	▪	▪	▪	14172-36E00-000
P008000005737	EXHAUST VALVE COVER GASKET, FRONT SIDE	1	▪	▪	▪	11238-36E01-000
X520002200200	O-RING (EXHAUST VALVE, LEFT SIDE)	1	▪	▪	▪	09280-23003-000
P018000005596	CLUTCH COVER GASKET	1	▪	▪	▪	11482-36F00-000
P025000005598	FRICTION DISC COVER GASKET	1	▪	▪	▪	1484-36E10-000
A826012016200	WASHER (OIL DRAIN)	1	▪	▪	▪	09168-12002-000
P014000005600	WATER PUMP GASKET	1	▪	▪	▪	17431-36F00-000
P016000005597	IGNITION COVER GASKET	1	▪	▪	▪	11483-36E11-000
P003000005599	CRANKCASE GASKET	1	▪	▪	▪	11481-36F30-000
A801006010100	WASHER (CLUTCH COVER/WATER PUMP)	2	▪	▪	▪	17413-28C10-000
X520002000200	O-RING (FRONT SPROCKET)	2	▪	▪	▪	09280-20006-000
X520001700300	O-RING (OIL FILLER CAP)	1	▪	▪	▪	09280-17003-000

XRADICAL
SUPER GASKETS



P02E000005601 | 11241-36F00-000 (0,3 mm)
P02F000005601 | - (0,4 mm)
P02G000005601 | - (0,5 mm) **K S J**

CYLINDER BASE GASKET (2003-2012)



P02E000005735 | 11241-27C10-000 (0,3 mm)
P02F000005735 | - (0,4 mm)
P02G000005735 | - (0,5 mm) **K S J**

CYLINDER BASE GASKET (2001 - 2006)



P008000005737 | 11238-36E01-000 **K S J**

EXHAUST VALVE COVER GASKET, FRONT SIDE



P008000005736 | 11233-27C34-000 **K S J**

EXHAUST VALVE COVER GASKET, RIGHT SIDE



P003000005599 | 11481-36F30-000 **J**

CRANKCASE GASKET



P018000005596 | 11482-36F00-000 **S J**

CLUTCH COVER GASKET

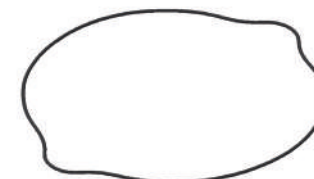

P025000005598 | 1484-36E10-000 **S J**

FRICTION DISC COVER GASKET



P016000005597 | 11483-36E11-000 **J**

IGNITION COVER GASKET



P014000005600 | 17431-36F00-000 **S J**

WATER PUMP GASKET

ARTEIN PART No.	DESCRIPTION	UNITS	TOP END KIT K0000YM0K0846	SMART KIT S0000YM0S0846	COMPLETE SET J0000YM000846	ORIGINAL PART No.
X560005050178	O-RING (CYLINDER HEAD GASKET, INNER)	1	▪	▪	▪	93210-50582-00
X520007600178	O-RING (CYLINDER HEAD GASKET, OUTER)	1	▪	▪	▪	93210-76MF8-00
P02E000005426	CYLINDER BASE GASKET (0,3 MM)	1	▪	▪	▪	-
P02F000005426	CYLINDER BASE GASKET (0,4 MM)	1	▪	▪	▪	-
P02G000005426	CYLINDER BASE GASKET (0,5 MM)	1	▪	▪	▪	BR8-11351-00
P02H000005426	CYLINDER BASE GASKET (0,6 MM)	1	▪	▪	▪	-
P025000005427	EXHAUST VALVE COVER GASKET, RIGHT SIDE	1	▪	▪	▪	BR8-11993-00
X560003777262	O-RING (EXHAUST GASKET)	2	▪	▪	▪	BR8-14642-00
A820008014200	WASHER (CYLINDER HEAD)	5	▪	▪	▪	90201-066F0-00
A820005009100	WASHER (EXHAUST VALVE)	4	▪	▪	▪	92902-05600-00
P025000005428	EXHAUST VALVE COVER GASKET, FRONT SIDE	1	▪	▪	▪	BR8-11354-00
P018000005430	CLUTCH COVER GASKET	1	▪	▪	▪	BR8-15461-00
P025000005431	FRICTION DISC COVER GASKET	1	▪	▪	▪	5PA-15463-00
A820008014150	WASHER (CLUTCH COVER)	1	▪	▪	▪	90430-08119-00
P014000005429	WATER PUMP COVER GASKET	1	▪	▪	▪	BR8-12428-00
P016000005432	IGNITION COVER GASKET	1	▪	▪	▪	5PA-15451-00
X520001320240	O-RING (WATER HOSE SEAL)	1	▪	▪	▪	93210-132A7
A820006014100	WASHER (CRANKCASE)	1	▪	▪	▪	90430-06166-00
X520001900250	O-RING (OIL FILLER CAP)	1	▪	▪	▪	93210-19123-00



P02E000005426 (0,3 mm)
P02F000005426 (0,4 mm)
P02G000005426 BR8-11351-00 (0,5 mm)
P02H000005426 (0,6 mm)

CYLINDER BASE GASKET

K S J

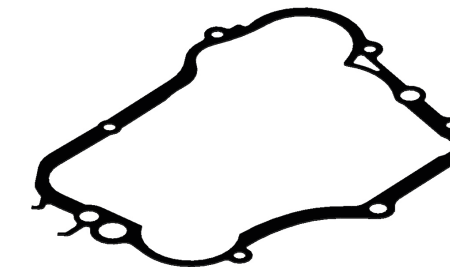

P018000005430 | BR8-15461-00

CLUTCH COVER GASKET

S J



P025000005431 | 5PA-15463-00

FRICTION DISC COVER GASKET

S J

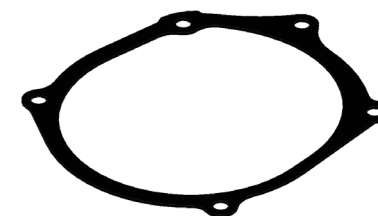

P016000005432 | 5PA-15451-00

IGNITION COVER GASKET

J



P014000005429 | BR8-12428-00

WATER PUMP GASKET

S J

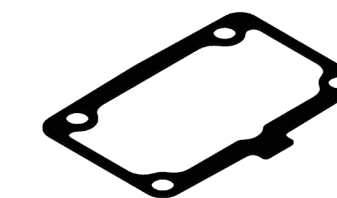

P025000005428 | BR8-11354-00

EXHAUST VALVE COVER GASKET, FRONT SIDE

K S J

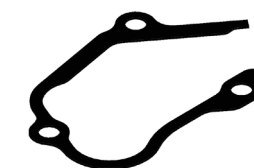

P025000005427 | BR8-11993-00

EXHAUST VALVE COVER GASKET, RIGHT SIDE

K S J

XRADICAL
SUPER GASKETS

ARTEIN PART No.	DESCRIPTION	UNITS	TOP END KIT K0000YM0K0847	SMART KIT S0000YM0S0847	COMPLETE SET J0000YM000847	ORIGINAL PART No.
X560005600180	O-RING (CYLINDER HEAD GASKET, INNER)	1	▪	▪	▪	93210-56459-00
X520008400180	O-RING (CYLINDER HEAD GASKET, OUTER)	1	▪	▪	▪	93210-84724-00
P02E000005433	CYLINDER BASE GASKET (0,3 MM)	1	▪	▪	▪	-
P02F000005433	CYLINDER BASE GASKET (0,4 MM)	1	▪	▪	▪	-
P02G000005433	CYLINDER BASE GASKET (0,5 MM)	1	▪	▪	▪	4ES-11351-00
P02H000005433	CYLINDER BASE GASKET (0,6 MM)	1	▪	▪	▪	-
P012000005434	EXHAUST GASKET	1	▪	▪	▪	90201-34683-00
X560003700260	O-RING (EXHAUST GASKET)	2	▪	▪	▪	5PA-14642-00
A820008016150	WASHER (CYLINDER HEAD GASKET)	4	▪	▪	▪	90201-080L8-00
P018000005436	CLUTCH COVER GASKET	1	▪	▪	▪	4ES-15461-00
P025000005431	FRICTION DISC COVER GASKET	1	▪	▪	▪	5PA-15463-00
A820008014150	WASHER (CLUTCH COVER)	1	▪	▪	▪	90430-08119-00
A820006014100	WASHER (WATER PUMP)	1	▪	▪	▪	90430-06166-00
P014000005435	WATER PUMP COVER GASKET	1	▪	▪	▪	4BA-12428-00
P016000005432	IGNITION COVER GASKET	1	▪	▪	▪	5PA-15451-00
X520001900250	O-RING (OIL FILLER CAP)	1	▪	▪	▪	93210-19123-00

XRADICAL
SUPER GASKETS

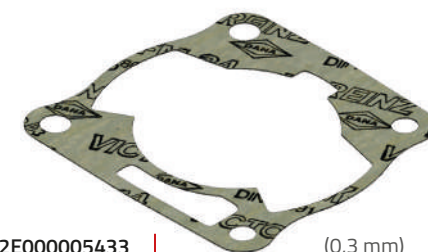

P02E000005433 (0,3 mm)
P02F000005433 (0,4 mm)
P02G000005433 4ES-11351-00 (0,5 mm)
P02H000005433 (0,6 mm)

CYLINDER BASE GASKET

K S J



P012000005434 | 90201-34683-00

EXHAUST GASKET

K S J

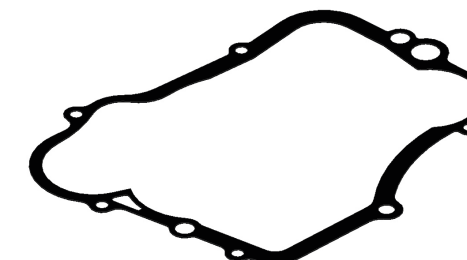

P018000005436 | 4ES-15461-00

CLUTCH COVER GASKET

S J



P025000005431 | 5PA-15463-00

FRICTION DISC COVER GASKET

S J

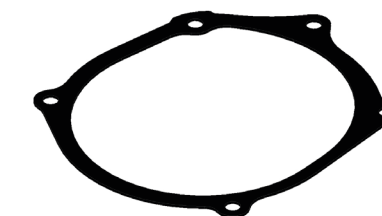

P016000005432 | 5PA-15451-00

IGNITION COVER GASKET

J



P014000005435 | 4BA-12428-00

WATER PUMP GASKET

S J

ARTEIN PART No.	DESCRIPTION	UNITS	TOP END KIT K0000YM0K0881	SMART KIT S0000YM0S0881	COMPLETE SET J0000YM000881	ORIGINAL PART No.
X560005600180	O-RING (CYLINDER HEAD GASKET, INNER)	1	▪	▪	▪	93210-56459-00
X520008400180	O-RING (CYLINDER HEAD GASKET, OUTER)	1	▪	▪	▪	93210-84724-00
P02E000005609	CYLINDER BASE GASKET (0,30 MM)	1	▪	▪	▪	-
P02F000005609	CYLINDER BASE GASKET (0,40 MM)	1	▪	▪	▪	-
P02G000005609	CYLINDER BASE GASKET (0,50 MM)	1	▪	▪	▪	B4B-11351-00
P02H000005609	CYLINDER BASE GASKET (0,60 MM)	1	▪	▪	▪	-
X560003970353	O-RING (EXHAUST)	2	▪	▪	▪	93210-40745-00
A820008016150	WASHER (CYLINDER HEAD GASKET)	4	▪	▪	▪	90201-080L8-00
P025000005610	EXHAUST VALVE GASKET, RIGHT SIDE	1	▪	▪	▪	B4B-11993-00
P025000005439	EXHAUST VALVE COVER GASKET, FRONT SIDE	1	▪	▪	▪	1C3-11354-00
A820005009100	WASHER (EXHAUST VALVE COVER)	7	▪	▪	▪	92902-05600-00
P018000005436	CLUTCH COVER GASKET	1	▪	▪	▪	BR8-15461-00
P025000005431	FRICTION DISC COVER GASKET	1	▪	▪	▪	5PA-15463-00
A820006014100	WASHER (WATER PUMP)	1	▪	▪	▪	90430-06166-00
X520001320240	O-RING (WATER HOSE SEAL)	1	▪	▪	▪	93210-132A7
P014000005429	WATER PUMP GASKET	1	▪	▪	▪	BR8-12428-00
P016000005432	IGNITION COVER GASKET	1	▪	▪	▪	5PA-15451-00
A820008014150	WASHER (CLUTCH COVER)	1	▪	▪	▪	90430-08119-00
X520001900250	O-RING (OIL FILLER CAP)	1	▪	▪	▪	93210-19123-00



P02E000005609 - 0,30 mm
 P02F000005609 - 0,40 mm
 P02G000005609 B4B-11351-00 0,50 mm
 P02H000005609 - 0,60 mm

▲ **P02E000005609** | - 0,30 mm **K S J**
 ▲ **P02F000005609** | - 0,40 mm **K S J**
 ▲ **P02G000005609** | B4B-11351-00 0,50 mm **K S J**
 ▲ **P02H000005609** | - 0,60 mm **K S J**

CYLINDER BASE GASKET



▲ **P025000005610** | B4B-11993-00 **K S J**

EXHAUST VALVE GASKET, RIGHT SIDE



▲ **P025000005439** | 1C3-11354-00 **K S J**

EXHAUST VALVE COVER GASKET, FRONT SIDE



▲ **P018000005436** | BR8-15461-00 **S J**

CLUTCH COVER GASKET



▲ **P025000005431** | 5PA-15463-00 **S J**

FRICTION DISC COVER GASKET



▲ **P016000005432** | 5PA-15451-00 **J**

IGNITION COVER GASKET



▲ **P014000005429** | BR8-12428-00 **S J**

WATER PUMP GASKET



ARTEIN PART No.	DESCRIPTION	UNITS	TOP END KIT K0000YM0K0849	SMART KIT S0000YM0S0849	COMPLETE SET J0000YM000849	ORIGINAL PART No.
X560006350178	O-RING (CYLINDER HEAD GASKET, INNER)	1	▪	▪	▪	93210-63442-00
X520009050178	O-RING (CYLINDER HEAD GASKET, OUTER)	1	▪	▪	▪	93210-90785-00
P02H000005437	CYLINDER BASE GASKET (0,6 MM)	1	▪	▪	▪	-
P02I000005437	CYLINDER BASE GASKET (0,8 MM)	1	▪	▪	▪	1C3-11351-00
P025000005438	EXHAUST VALVE COVER GASKET, RIGHT SIDE	1	▪	▪	▪	1C3-11993-00
X560004500350	O-RING (EXHAUST SEAL)	2	▪	▪	▪	5MV-14642-00
A820008016150	WASHER (CYLINDER HEAD GASKET)	5	▪	▪	▪	90201-080L8-00
A820005009100	WASHER (EXHAUST VALVE)	4	▪	▪	▪	92902-05600-00
P025000005439	EXHAUST VALVE COVER GASKET, FRONT SIDE	1	▪	▪	▪	1C3-11354-00
P018000005441	CLUTCH COVER GASKET	1	▪	▪	▪	1C3-15462-00
P025000005442	FRICTION DISC COVER GASKET	1	▪	▪	▪	1C3-15463-00
A820007012100	WASHER (WATER PUMP/FRICTION DISC)	2	▪	▪	▪	90430-06014-00
P014000005440	WATER PUMP COVER GASKET	1	▪	▪	▪	1C3-12428-00
P016000005443	IGNITION COVER GASKET	1	▪	▪	▪	1C3-15451-00
X520001650200	O-RING (WATER HOSE SEAL)	1	▪	▪	▪	93210-16314-00
A820007011150	WASHER (IGNITION COVER)	1	▪	▪	▪	92990-06600-00
A820011017150	WASHER (OIL PIPE)	1	▪	▪	▪	90430-10188-00
X520001900250	O-RING (OIL FILLER CAP)	1	▪	▪	▪	93210-19123-00



P02H000005437 (0,6 mm)
P02I000005437 1C3-11351-00 (0,75 mm) **K S J**
CYLINDER BASE GASKET

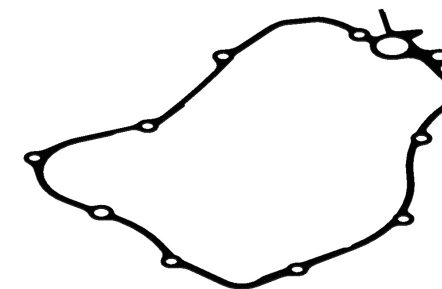

P018000005441 | 1C3-15462-00 **S J**
CLUTCH COVER GASKET

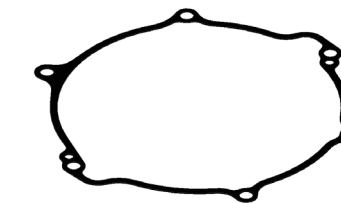

P025000005442 | 1C3-15463-00 **S J**
FRICTION DISC COVER GASKET

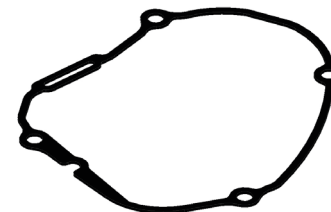

P016000005443 | 1C3-15451-00 **J**
IGNITION COVER GASKET

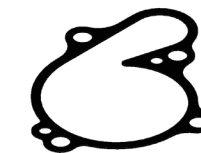

P014000005440 | 1C3-12428-00 **S J**
WATER PUMP GASKET

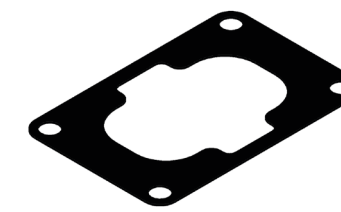

P025000005439 | 1C3-11354-00 **K S J**
EXHAUST VALVE COVER GASKET, FRONT SIDE



P025000005438 | 1C3-11993-00 **K S J**
EXHAUST VALVE COVER GASKET, RIGHT SIDE

XRADICAL
SUPER GASKETS

ARTEIN PART No.	DESCRIPTION	UNITS	TOP END KIT K0000YM0K0882	SMART KIT S0000YM0S0882	COMPLETE SET J0000YM000882	ORIGINAL PART No.
X560006350178	O-RING (CYLINDER HEAD GASKET, INNER)	1	▪	▪	▪	93210-63442-00
X560009050178	O-RING (CYLINDER HEAD GASKET, OUTER)	1	▪	▪	▪	93210-90785-00
P02H000005611	CYLINDER BASE GASKET (0,60 MM)	1	▪	▪	▪	-
P02I000005611	CYLINDER BASE GASKET (0,80 MM)	1	▪	▪	▪	B4X-11351-00
P025000005612	EXHAUST VALVE COVER GASKET, RIGHT SIDE	1	▪	▪	▪	B4X-11993-00
P025000005439	EXHAUST VALVE COVER GASKET, FRONT SIDE	1	▪	▪	▪	1C3-11354-00
A820005009100	WASHER (EXHAUST VALVE COVER)	4	▪	▪	▪	92902-05600-00
P015000005613	REED VALVE GASKET	1	▪	▪	▪	B4X-13621-00
X560004150355	O-RING (EXHAUST)	2	▪	▪	▪	93210-42728-00
A820008016150	WASHER (CYLINDER HEAD GASKET)	5	▪	▪	▪	90201-080L8-00
P018000005441	CLUTCH COVER GASKET	1	▪	▪	▪	1C3-15462-00
P025000005442	FRICTION DISC COVER GASKET	1	▪	▪	▪	1C3-15463-00
A820007012100	WASHER (WATER PUMP/FRICTION DISC)	2	▪	▪	▪	90430-06014-00
P014000005440	WATER PUMP GASKET	1	▪	▪	▪	1C3-12428-00
P016000005443	IGNITION COVER GASKET	1	▪	▪	▪	1C3-15451-00
X520001650200	O-RING (WATER HOSE SEAL)	1	▪	▪	▪	93210-16314-00
A820007011150	WASHER (IGNITION COVER)	1	▪	▪	▪	92990-06600-00
A820011017150	WASHER (OIL PIPE)	1	▪	▪	▪	90430-10188-00
X520001900250	O-RING (OIL FILLER CAP)	1	▪	▪	▪	93210-19123-00



P02I000005611 | - | 0,60 mm
 ▲ P02I000005611 | B4X-11351-00 | 0,80 mm **K S J**
 CYLINDER BASE GASKET



▲ P025000005612 | B4X-11993-00 **K S J**
 EXHAUST VALVE COVER GASKET, RIGHT SIDE

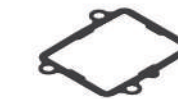

▲ P015000005613 | B4X-13621-00 **K S J**
 REED VALVE GASKET

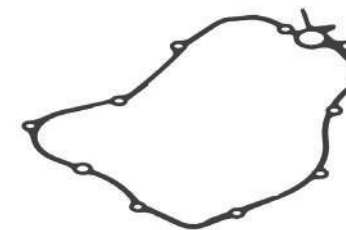

▲ P018000005441 | 1C3-15462-00 **S J**
 CLUTCH COVER GASKET

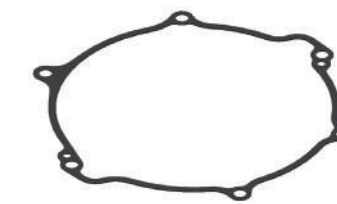

▲ P025000005442 | 1C3-15463-00 **S J**
 FRICTION DISC COVER GASKET



▲ P016000005443 | 1C3-15451-00 **J**
 IGNITION COVER GASKET

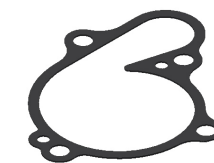

▲ P014000005440 | 1C3-12428-00 **S J**
 WATER PUMP GASKET

XRADICAL
SUPER GASKETS

ARTEIN PART No.	DESCRIPTION	UNITS	TOP END KIT K0000YM0K0851	SMART KIT S0000YM0S0851	COMPLETE SET J0000YM000851	ORIGINAL PART No.
X560007450200	O-RING (CYLINDER HEAD GASKET, INNER)	1	▪	▪	▪	93210-74316-00
X520010300200	O-RING (CYLINDER HEAD GASKET, OUTER)	1	▪	▪	▪	93211-02703-00
P02H000005444	CYLINDER BASE GASKET (0,6 MM)	1	▪	▪	▪	-
P02I000005444	CYLINDER BASE GASKET (0,8 MM)	1	▪	▪	▪	5UP-11351-00
P015000005447	REED VALVE GASKET	1	▪	▪	▪	5XF-13622-00
P025000005445	EXHAUST VALVE COVER GASKET, RIGHT SIDE	1	▪	▪	▪	5CU-11993-00
X560005400300	O-RING (EXHAUST SEAL)	2	▪	▪	▪	5MW-14642-00
A820008016150	WASHER (CYLINDER HEAD GASKET)	6	▪	▪	▪	90201-080L8-00
P025000005446	EXHAUST VALVE COVER GASKET, FRONT SIDE	1	▪	▪	▪	5CU-11354-00
X560001500178	O-RING (EXHAUST VALVE SHAFT)	2	▪	▪	▪	93210-15639-00
P018000005450	CLUTCH COVER GASKET	1	▪	▪	▪	5CU-15462-00
P025000005451	FRICTION DISC COVER GASKET (O-RING)	1	▪	▪	▪	5CU-15463-00
A820007011150	WASHER (OIL DRAIN)	2	▪	▪	▪	92990-06600-00
A820007012100	WASHER (OIL DRAIN)	1	▪	▪	▪	90430-06014-00
A820012020150	WASHER (OIL DRAIN)	1	▪	▪	▪	90430-12227-00
P014000005448	WATER PUMP COVER GASKET	1	▪	▪	▪	5XF-12428-00
P016000005452	IGNITION COVER GASKET	1	▪	▪	▪	5CU-15451-00
X520002200180	O-RING (FRONT SPROCKET)	1	▪	▪	▪	93210-22298-00
P014000005449	WATER HOSE SEAL (O-RING)	1	▪	▪	▪	5CU-15454-00
X520001900250	O-RING (OIL FILLER CAP)	1	▪	▪	▪	93210-19123-00

XRADICAL
SUPER GASKETS



P02H000005444 (0,6 mm)
P02I000005444 5UP-11351-00 (0,75 mm) **K S J**
CYLINDER BASE GASKET



P018000005450 | 5CU-15462-00 **S J**
CLUTCH COVER GASKET

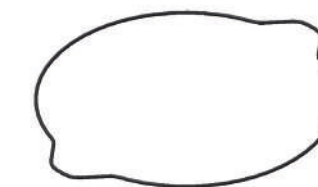

P025000005451 | 5CU-15463-00 **S J**
FRICTION DISC COVER GASKET (O-RING)



P016000005452 | 5CU-15451-00 **J**
IGNITION COVER GASKET



P014000005448 | 5XF-12428-00 **S J**
WATER PUMP COVER GASKET

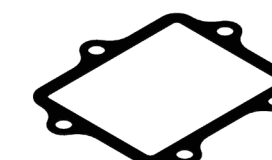

P015000005447 | 5XF-13622-00 **K S J**
REED VALVE GASKET

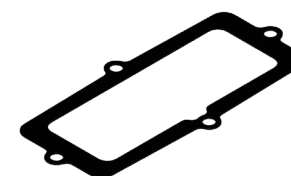

P025000005446 | 5CU-11354-00 **K S J**
EXHAUST VALVE COVER GASKET, FRONT SIDE



P025000005445 | 5CU-11993-00 **K S J**
EXHAUST VALVE COVER GASKET, RIGHT SIDE



P014000005449 | 5CU-15454-00 **J**
WATER HOSE SEAL (O-RING)

ARTEIN PART No.	DESCRIPTION	UNITS	TOP END KIT K0000YM0K0810	SMART KIT S0000YM0S0810	COMPLETE SET J0000YM000810	ORIGINAL PART No.
P001000005140	CYLINDER HEAD GASKET	1	▪	▪	▪	5NL-11181-00
P02H000005139	CYLINDER BASE GASKET (0,6 MM)	1	▪	▪	▪	5NL-11351-00
P012000XR5141	EXHAUST GASKET	1	▪	▪	▪	5NL-14613-00
P010000005143	DISTRIBUTION TENSIONER GASKET	1	▪	▪	▪	4FM-12213-00
A820007012100	WASHER (CYLINDER HEAD)	1	▪	▪	▪	90430-06014-00
A820006014100	WASHER (DISTRIBUTION TENSIONER)	1	▪	▪	▪	5EL-12214-00
KRV00YMOV0810	VALVE STEM SEALS KIT	1	▪	▪	▪	-
P025000005145	FRICITION DISC COVER GASKET	1	▪	▪	▪	5NL-15453-10
P018000005146	CLUTCH COVER GASKET	1	▪	▪	▪	5NL-15462-00
P014000005142	WATER PUMP COVER GASKET (O-RING)	1	▪	▪	▪	5NL-12439-00
A820007012100	WASHER (WATER PUMP)	1	▪	▪	▪	90430-06014-00
X520006000300	O-RING (ELECTRIC START)	1	▪	▪	▪	93210-60426-00
X520001366230	O-RING (IGNITION COVER)	1	▪	▪	▪	93210-14369-00
X520002700250	O-RING (IGNITION COVER)	1	▪	▪	▪	93210-27778-00
X520003200220	O-RING (IGNITION COVER)	1	▪	▪	▪	93210-32172-00
X520000700240	O-RING (OIL FILTER)	2	▪	▪	▪	93210-07135-00
X520004700250	O-RING (OIL FILTER)	1	▪	▪	▪	93210-47675-00
X520000650178	O-RING (OIL PIPE)	1	▪	▪	▪	93210-07003-00
X520000900150	O-RING (OIL PIPE)	1	▪	▪	▪	93210-09008-00
X520001242178	O-RING (OIL PIPE)	1	▪	▪	▪	93210-12759-00
X520001000180	O-RING (OIL PUMP)	5	▪	▪	▪	93210-10197-00
X520001900150	O-RING (FRONT SPROCKET)	1	▪	▪	▪	93210-196A4-00
X520001600190	O-RING (WATER HOSE SEAL)	2	▪	▪	▪	93210-16716-00
A820008014150	WASHER (OIL PIPE)	4	▪	▪	▪	90430-08119-00
A820011017150	WASHER (OIL PIPE)	3	▪	▪	▪	90430-10188-00
P016000005144	IGNITION COVER GASKET	1	▪	▪	▪	5NL-15451-00
P016000005608	IGNITION COVER GASKET (WR 250F)	1	▪	▪	▪	5UM-15451-00
X520001900250	O-RING (OIL FILLER CAP)	1	▪	▪	▪	93210-19123-00

RELATED PRODUCTS	
ARTEIN PART No.	DESCRIPTION
KRV00YMOV0810	VALVE STEM SEALS KIT



▲ P02H000005139 | 5NL-11351-00 **K S J**
CYLINDER BASE GASKET



▲ P001000005140 | 5NL-11181-00 **K S J**
CYLINDER HEAD GASKET



▲ P012000XR5141 | 5NL-14613-00 **K S J**
EXHAUST GASKET



▲ P018000005146 | 5NL-15462-00 **S J**
CLUTCH COVER GASKET



▲ P025000005145 | 5NL-15453-10 **S J**
FRICITION DISC COVER GASKET



▲ P016000005144 | 5NL-15451-00 **J**
IGNITION COVER GASKET



▲ P016000005608 | 5UM-15451-00 **J**
IGNITION COVER GASKET (WR 250F)



▲ P014000005142 | 5NL-12439-00 **S J**
WATER PUMP COVER GASKET



▲ P010000005143 | 4FM-12213-00 **K S J**
DISTRIBUTION CHAIN TENSIONER GASKET

ARTEIN PART No.	DESCRIPTION	UNITS	TOP END KIT K0000YM0K0811	SMART KIT S0000YM0S0811	COMPLETE SET J0000YM000811	ORIGINAL PART No.
P001000005149	CYLINDER HEAD GASKET	1	▪	▪	▪	1SM-11181-00
P02D000005148	CYLINDER BASE GASKET (0,25 MM)	1	▪	▪	▪	1SM-11351-00
P012000XR5141	EXHAUST GASKET	1	▪	▪	▪	5NL-14613-00
P010000005143	DISTRIBUTION TENSIONER GASKET	1	▪	▪	▪	4FM-12213-00
A820007012100	WASHER (CYLINDER HEAD)	1	▪	▪	▪	90430-06014-00
A820006014100	WASHER (DISTRIBUTION TENSIONER)	1	▪	▪	▪	5EL-12214-00
KRV00YMOV0811	VALVE STEM SEALS KIT	1	▪	▪	▪	-
P018000005153	CLUTCH COVER GASKET	1	▪	▪	▪	1SM-15462-00
P025000005152	FRICTION DISC COVER GASKET	1	▪	▪	▪	1SM-15453-00
X520001600190	O-RING (WATER HOSE SEAL)	1	▪	▪	▪	93210-16716-00
A820011017150	WASHER (OIL DRAIN)	1	▪	▪	▪	90430-10188-00
P014000005150	WATER PUMP COVER GASKET	1	▪	▪	▪	33D-12427-00
A820007012100	WASHER (WATER PUMP)	1	▪	▪	▪	90430-06014-00
P016000005151	IGNITION COVER GASKET	1	▪	▪	▪	1SM-15451-00
X520001366230	O-RING (IGNITION COVER)	1	▪	▪	▪	93210-14369-00
X520003459262	O-RING (IGNITION COVER)	1	▪	▪	▪	93210-357A3-00
X520005800190	O-RING (ELECTRIC START)	1	▪	▪	▪	93210-58346-00
X520001250180	O-RING (OIL FILTER)	1	▪	▪	▪	93210-12010-00
X520004450182	O-RING (OIL FILTER)	1	▪	▪	▪	93210-45708-00
X520001900150	O-RING (FRONT SPROCKET)	1	▪	▪	▪	93210-196A4-00
X520001560240	O-RING (WATER HOSE SEAL)	1	▪	▪	▪	93210-16275-00
X520001630240	O-RING (WATER HOSE SEAL)	1	▪	▪	▪	93210-16500-00
X520001900250	O-RING (OIL FILLER CAP)	1	▪	▪	▪	93210-19123-00

RELATED PRODUCTS

ARTEIN PART No.	DESCRIPTION
KRV00YMOV0811	VALVE STEM SEALS KIT

XRADICAL
SUPER GASKETS

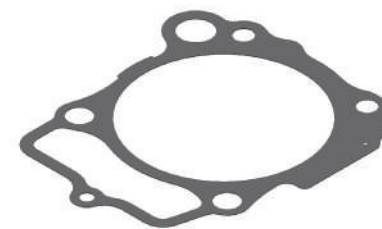

▲ P02D000005148 | 1SM-11351-00 **K S J**
CYLINDER BASE GASKET



▲ P001000005149 | 1SM-11181-00 **K S J**
CYLINDER HEAD GASKET



▲ P012000XR5141 | 5NL-14613-00 **K S J**
EXHAUST GASKET

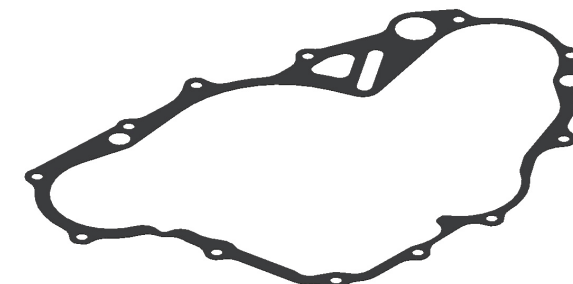

▲ P018000005153 | 1SM-15462-00 **S J**
CLUTCH COVER GASKET

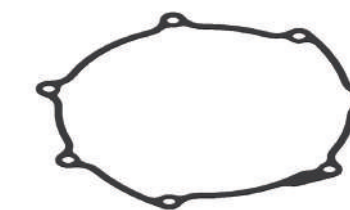

▲ P025000005152 | 1SM-15453-00 **S J**
FRICTION DISC COVER GASKET

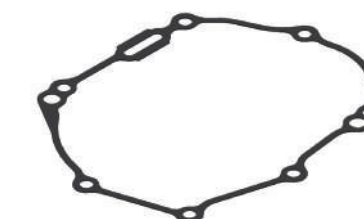

▲ P016000005151 | 1SM-15451-00 **J**
IGNITION COVER GASKET



▲ P014000005150 | 33D-12427-00 **S J**
WATER PUMP COVER GASKET



▲ P010000005143 | 4FM-12213-00 **K S J**
DISTRIBUTION CHAIN TENSIONER GASKET

ARTEIN PART No.	DESCRIPTION	UNITS	TOP END KIT K0000YM0K0818	SMART KIT S0000YM0S0818	COMPLETE SET J0000YM000818	ORIGINAL PART No.
P001000005183	CYLINDER HEAD GASKET	1	▪	▪	▪	5TA-11181-00
P02H000005182	CYLINDER BASE GASKET (0,6 MM)	1	▪	▪	▪	5TA-11351-00
P012000XR5163	EXHAUST GASKET	1	▪	▪	▪	3VD-14613-01
P010000005143	DISTRIBUTION TENSIONER GASKET	1	▪	▪	▪	4FM-12213-00
A820007012100	WASHER (CYLINDER HEAD/DISTRIBUTION TENSIONER)	2	▪	▪	▪	90430-06014-00
A820008014150	WASHER (OIL PIPE)	4	▪	▪	▪	90430-08119-00
KRV00YMOV0377	VALVE STEM SEALS KIT	1	▪	▪	▪	-
X520001900182	O-RING (WATER HOSE SEAL)	1	▪	▪	▪	93210-19758-00
P018000005184	CLUTCH COVER GASKET	1	▪	▪	▪	5TA-15462-00
P025000005160	FRICTION DISC COVER GASKET	1	▪	▪	▪	5TA-15453-00
X520001900182	O-RING (WATER HOSE SEAL)	1	▪	▪	▪	93210-19758-00
A820007012100	WASHER (WATER PUMP)	1	▪	▪	▪	90430-06014-00
P014000005158	WATER PUMP COVER GASKET	1	▪	▪	▪	5BE-12439-00
P016000005185	IGNITION COVER GASKET	1	▪	▪	▪	5TJ-15451-00
X520005800190	O-RING (ELECTRIC START)	1	▪	▪	▪	93210-58346-00
X520001366230	O-RING (IGNITION COVER)	1	▪	▪	▪	93210-14369-00
X520002700250	O-RING (IGNITION COVER)	1	▪	▪	▪	93210-27370-00
X520000650178	O-RING (OIL FILTER)	1	▪	▪	▪	93210-07003-00
X520000700240	O-RING (OIL FILTER)	3	▪	▪	▪	93210-07135-00
X520000900150	O-RING (OIL FILTER)	1	▪	▪	▪	93210-09008-00
X520001242178	O-RING (OIL FILTER)	1	▪	▪	▪	93210-12759-00
X520004700250	O-RING (OIL FILTER)	1	▪	▪	▪	93210-47675-00
X520001000180	O-RING (OIL PUMP)	4	▪	▪	▪	93210-10197-00
X520002200180	O-RING (FRONT SPROCKET)	1	▪	▪	▪	93210-22164-00
X520001630240	O-RING (WATER HOSE SEAL)	2	▪	▪	▪	93210-16500-00
A820011017150	WASHER (OIL PIPE)	3	▪	▪	▪	90430-10188-00
A820007012100	WASHER (CRANKCASE)	1	▪	▪	▪	90430-06014-00
X520001900250	O-RING (OIL FILLER CAP)	1	▪	▪	▪	93210-19123-00

RELATED PRODUCTS	
ARTEIN PART No.	DESCRIPTION
KRV00YMOV0377	VALVE STEM SEALS KIT



 <p>▲ P02H000005182 5TA-11351-00 K S J CYLINDER BASE GASKET</p>	 <p>▲ P001000005183 5TA-11181-00 K S J CYLINDER HEAD GASKET</p>	 <p>▲ P012000XR5163 3VD-14613-01 K S J EXHAUST GASKET</p>
 <p>▲ P018000005184 5TA-15462-00 S J CLUTCH COVER GASKET</p>	 <p>▲ P025000005160 5TA-15453-00 S J FRICTION DISC COVER GASKET</p>	 <p>▲ P016000005185 5TJ-15451-00 J IGNITION COVER GASKET</p>
 <p>▲ P014000005158 5BE-12439-00 S J WATER PUMP COVER GASKET</p>	 <p>▲ P010000005143 4FM-12213-00 K S J DISTRIBUTION CHAIN TENSIONER GASKET</p>	

ARTEIN PART No.	DESCRIPTION	UNITS	TOP END KIT K0000YM0K0819	SMART KIT S0000YM0S0819	COMPLETE SET J0000YM000819	ORIGINAL PART No.
P001000005157	CYLINDER HEAD GASKET	1	▪	▪	▪	2S2-11181-00
P02D000005156	CYLINDER BASE GASKET (0,25 MM)	1	▪	▪	▪	2S2-11351-00
P012000XR5163	EXHAUST GASKET	1	▪	▪	▪	3VD-14613-01
P010000005143	DISTRIBUTION TENSIONER GASKET	1	▪	▪	▪	4FM-12213-00
A820007012100	WASHER (CYLINDER HEAD/DISTRIBUTION TENSIONER)	2	▪	▪	▪	90430-06014-00
A820006014100	WASHER (DISTRIBUTION TENSIONER)	1	▪	▪	▪	5EL-12214-00
KRV00YMOV0377	VALVE STEM SEALS KIT	1	▪	▪	▪	-
P018000005161	CLUTCH COVER GASKET	1	▪	▪	▪	2S2-15462-10
P025000005160	FRICTION DISC COVER GASKET	1	▪	▪	▪	5TA-15453-00
X520001900182	O-RING (WATER HOSE SEAL)	1	▪	▪	▪	93210-19758-00
A820007012100	WASHER (WATER PUMP)	1	▪	▪	▪	90430-06014-00
P014000005158	WATER PUMP COVER GASKET	1	▪	▪	▪	5BE-12439-00
P016000005159	IGNITION COVER GASKET	1	▪	▪	▪	2S2-15451-00
X520005800190	O-RING (ELECTRIC START)	1	▪	▪	▪	93210-58346-00
X520001366230	O-RING (IGNITION COVER)	1	▪	▪	▪	93210-14369-00
X520002700250	O-RING (IGNITION COVER)	1	▪	▪	▪	93210-27370-00
X520000700240	O-RING (OIL FILTER)	3	▪	▪	▪	93210-07135-00
X520004700250	O-RING (OIL FILTER)	1	▪	▪	▪	93210-47675-00
X520001000180	O-RING (OIL PUMP)	1	▪	▪	▪	93210-10197-00
X520002200180	O-RING (FRONT SPROCKET)	1	▪	▪	▪	93210-22164-00
X520001630240	O-RING (WATER HOSE SEAL)	2	▪	▪	▪	93210-16500-00
A820011017150	WASHER (OIL PIPE)	1	▪	▪	▪	90430-10188-00
A820007012100	WASHER (CRANKCASE)	1	▪	▪	▪	90430-06014-00
A820008014150	WASHER (OIL PIPE)	2	▪	▪	▪	90430-08119-00
X520000892183	O-RING (OIL LEVEL CAP)	1	▪	▪	▪	93210-09165-00
X520000780180	O-RING (IGNITION COVER)	1	▪	▪	▪	93210-08003-00
X520001900250	O-RING (OIL FILLER CAP)	1	▪	▪	▪	93210-19123-00

RELATED PRODUCTS	
ARTEIN PART No.	DESCRIPTION
KRV00YMOV0377	VALVE STEM SEALS KIT

XRADICAL
SUPER GASKETS



▲ P02D000005156 | 2S2-11351-00 **K S J**
CYLINDER BASE GASKET



▲ P001000005157 | 2S2-11181-00 **K S J**
CYLINDER HEAD GASKET



▲ P012000XR5163 | 3VD-14613-01 **K S J**
EXHAUST GASKET

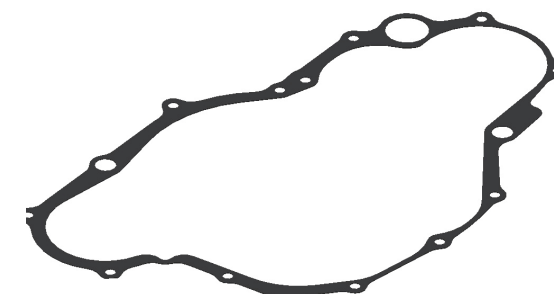

▲ P018000005161 | 2S2-15462-10 **S J**
CLUTCH COVER GASKET

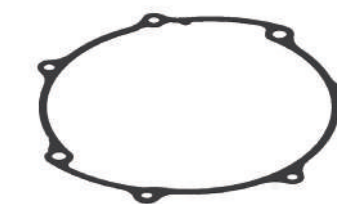

▲ P025000005160 | 5TA-15453-00 **S J**
FRICTION DISC COVER GASKET

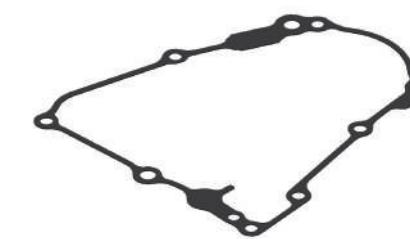

▲ P016000005159 | 2S2-15451-00 **J**
IGNITION COVER GASKET

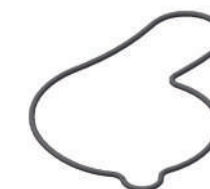

▲ P014000005158 | 5BE-12439-00 **S J**
WATER PUMP COVER GASKET



▲ P010000005143 | 4FM-12213-00 **K S J**
DISTRIBUTION CHAIN TENSIONER GASKET

ARTEIN PART No.	DESCRIPTION	UNITS	TOP END KIT K0000YM0K0377	SMART KIT S0000YM0S0377	COMPLETE SET J0000YM000377	ORIGINAL PART No.
P001000004202	CYLINDER HEAD GASKET	1	▪	▪	▪	5TA-11181-00
P02G000004204	CYLINDER BASE GASKET (0,5 MM)	1	▪	▪	▪	5TA-11351-00
P012000XR4234	EXHAUST GASKET	1	▪	▪	▪	3VD-14613-01
P010000004203	DISTRIBUTION TENSIONER GASKET	1	▪	▪	▪	4FM-12213-00
A820007012100	WASHER (CYLINDER HEAD)	1	▪	▪	▪	90430-06014-00
KRV00YMOV0377	VALVE STEM SEALS KIT	1	▪	▪	▪	-
X520001900182	O-RING (WATER HOSE SEAL)	2	▪	▪	▪	93210-19758-00
P003000004200	CLUTCH COVER GASKET	1	▪	▪	▪	5TA-15462-00
P016000004201	FRICTION DISC COVER GASKET	1	▪	▪	▪	5TA-15453-00
A820010014150	WASHER (OIL PIPE)	1	▪	▪	▪	90430-10148-00
P014000005158	WATER PUMP COVER GASKET	1	▪	▪	▪	5BE-12439-00
P018000004205	IGNITION COVER GASKET	1	▪	▪	▪	5TG-15451-00
A820007012100	WASHER (WATER PUMP)	2	▪	▪	▪	90430-06014-00
X520001630240	O-RING (WATER HOSE SEAL)	2	▪	▪	▪	93210-16500-00
X520001000180	O-RING (OIL PUMP)	4	▪	▪	▪	93210-10197-00
X520000650178	O-RING (OIL PIPE)	1	▪	▪	▪	93210-07003-00
X520000900150	O-RING (OIL PIPE)	1	▪	▪	▪	93210-09008-00
X520001242178	O-RING (OIL PIPE)	1	▪	▪	▪	93210-12759-00
X520004700250	O-RING (OIL FILTER)	1	▪	▪	▪	93210-47675-00
X560000700250	O-RING (OIL FILTER)	3	▪	▪	▪	93210-07135-00
A820011017150	WASHER (OIL PIPE)	2	▪	▪	▪	90430-10188-00
A820008014150	WASHER (OIL PIPE)	4	▪	▪	▪	90430-08119-00
X520006000300	O-RING (ELECTRIC START)	1	▪	▪	▪	93210-60426-00
X520002700250	O-RING (IGNITION COVER)	1	▪	▪	▪	93210-27370-00
X520001366230	O-RING (IGNITION COVER)	1	▪	▪	▪	93210-14369-00
X520002200180	O-RING (FRONT SPROCKET)	1	▪	▪	▪	93210-22164-00
X520001900250	O-RING (OIL FILLER CAP)	1	▪	▪	▪	93210-19123-00

RELATED PRODUCTS	
ARTEIN PART No.	DESCRIPTION
KRV00YMOV0377	VALVE STEM SEALS KIT



▲ P02G000004204 | 5TA-11351-00 **K S J**
CYLINDER BASE GASKET



▲ P001000004202 | 5TA-11181-00 **K S J**
CYLINDER HEAD GASKET



▲ P003000004200 | 5TA-15462-00 **S J**
CLUTCH COVER GASKET



▲ P010000004203 | 4FM-12213-00 **K S J**
DISTRIBUTION TENSIONER GASKET

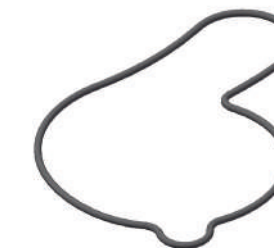

▲ P014000005158 | 5BE-12439-00 **S J**
WATER PUMP COVER GASKET



▲ P016000004201 | 5TA-15453-00 **S J**
FRICTION DISC COVER GASKET



▲ P018000004205 | 5TG-15451-00 **J**
IGNITION COVER GASKET



▲ P012000XR4234 | 3VD-14613-01 **K S J**
EXHAUST GASKET

ARTEIN PART No.	DESCRIPTION	UNITS	TOP END KIT K0000YM0K0812	SMART KIT S0000YM0S0812	COMPLETE SET J0000YM000812	ORIGINAL PART No.
P001000005157	CYLINDER HEAD GASKET	1	▪	▪	▪	2S2-11181-00
P02D000005156	CYLINDER BASE GASKET (0,25 MM)	1	▪	▪	▪	2S2-11351-00
P012000XR5163	EXHAUST GASKET	1	▪	▪	▪	3VD-14613-01
A820007012100	WASHER (CYLINDER HEAD/DISTRIBUTION TENSIONER)	2	▪	▪	▪	90430-06014-00
P010000005143	DISTRIBUTION TENSIONER GASKET	1	▪	▪	▪	4FM-12213-00
KRV00YMOV0377	VALVE STEM SEALS KIT	1	▪	▪	▪	-
P018000005161	CLUTCH COVER GASKET	1	▪	▪	▪	2S2-15462-10
P025000005160	FRICTION DISC COVER GASKET	1	▪	▪	▪	5TA-15453-00
A820007012100	WASHER (OIL DRAIN/WATER PUMP)	2	▪	▪	▪	90430-06014-00
X520001900182	O-RING (WATER HOSE SEAL)	1	▪	▪	▪	93210-19758-00
A820008014150	WASHER (OIL DRAIN)	1	▪	▪	▪	90430-08119-00
P014000005158	WATER PUMP COVER GASKET	1	▪	▪	▪	5BE-12439-00
P016000005159	IGNITION COVER GASKET	1	▪	▪	▪	2S2-15451-00
X520001000180	O-RING (CRANKCASE)	1	▪	▪	▪	93210-10197-00
X520006000300	O-RING (ELECTRIC START)	1	▪	▪	▪	93210-60426-00
X520000780180	O-RING (IGNITION COVER)	1	▪	▪	▪	93210-08003-00
X520001366230	O-RING (IGNITION COVER)	1	▪	▪	▪	93210-14369-00
X520002700250	O-RING (IGNITION COVER)	1	▪	▪	▪	93210-27778-00
X520000700240	O-RING (OIL FILTER)	3	▪	▪	▪	93210-07135-00
X520004700250	O-RING (OIL FILTER)	1	▪	▪	▪	93210-47675-00
X520002200180	O-RING (FRONT SPROCKET)	1	▪	▪	▪	93210-22164-00
X520001630240	O-RING (WATER HOSE SEAL)	2	▪	▪	▪	93210-16500-00
A820011017150	WASHER (OIL PIPE)	1	▪	▪	▪	90430-10188-00
X520000892183	O-RING (OIL LEVEL CAP)	1	▪	▪	▪	93210-09165-00
X520001900250	O-RING (OIL FILLER CAP)	1	▪	▪	▪	93210-19123-00

RELATED PRODUCTS	
ARTEIN PART No.	DESCRIPTION
KRV00YMOV0377	VALVE STEM SEALS KIT

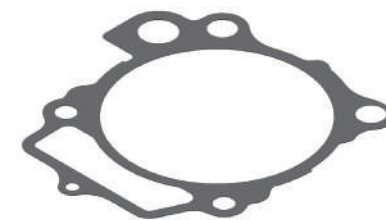

▲ P02C000005156 | 2S2-11351-00 **K S J**
CYLINDER BASE GASKET



▲ P001000005157 | 2S2-11181-00 **K S J**
CYLINDER HEAD GASKET



▲ P012000XR5163 | 3VD-14613-01 **K S J**
EXHAUST GASKET

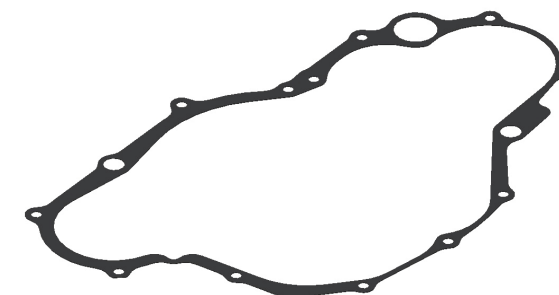

▲ P018000005161 | 2S2-15462-10 **S J**
CLUTCH COVER GASKET

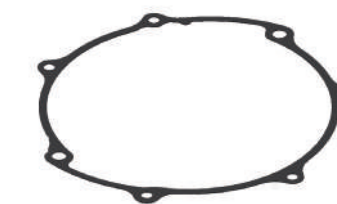

▲ P025000005160 | 5TA-15453-00 **S J**
FRICTION DISC COVER GASKET

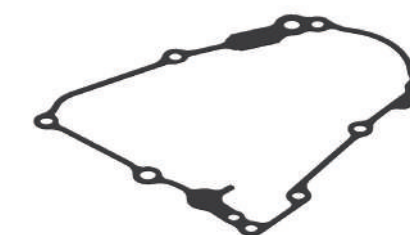

▲ P016000005159 | 2S2-15451-00 **J**
IGNITION COVER GASKET

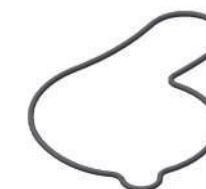

▲ P014000005158 | 5BE-12439-00 **S J**
WATER PUMP COVER GASKET



▲ P010000005143 | 4FM-12213-00 **K S J**
DISTRIBUTION CHAIN TENSIONER GASKET

ARTEIN PART No.	DESCRIPTION	UNITS	TOP END KIT K0000YM0K0815	SMART KIT S0000YM0S0815	COMPLETE SET J0000YM000815	ORIGINAL PART No.
P001000005165	CYLINDER HEAD GASKET	1	▪	▪	▪	33D-11181-00
P02D000005164	CYLINDER BASE GASKET (0,25 MM)	1	▪	▪	▪	33D-11351-00
P012000005169	EXHAUST GASKET	1	▪	▪	▪	33D-14613-00
A820007012100	WASHER (CYLINDER HEAD/DISTRIBUTION TENSIONER)	3	▪	▪	▪	90430-06014-00
A820006014100	WASHER (DISTRIBUTION TENSIONER)	1	▪	▪	▪	5EL-12214-00
A820008014150	WASHER (CYLINDER HEAD)	1	▪	▪	▪	90430-08119-00
KRV00HNOV0353	VALVE STEM SEALS KIT	1	▪	▪	▪	-
P010000005143	DISTRIBUTION TENSIONER GASKET	1	▪	▪	▪	4FM-12213-00
P018000005168	CLUTCH COVER GASKET	1	▪	▪	▪	33D-15462-00
P025000005167	FRICTION DISC COVER GASKET (O-RING)	1	▪	▪	▪	33D-15453-00
A820007012100	WASHER (WATER PUMP)	1	▪	▪	▪	90430-06014-00
X520001900182	O-RING (WATER HOSE SEAL)	1	▪	▪	▪	93210-19758-00
P014000005150	WATER PUMP COVER GASKET	1	▪	▪	▪	33D-12427-00
P016000005166	IGNITION COVER GASKET	1	▪	▪	▪	33D-15451-00
X520000650140	O-RING (CRANKCASE)	1	▪	▪	▪	93210-07001-00
X520001366230	O-RING (IGNITION COVER)	1	▪	▪	▪	93210-14369-00
X520003459262	O-RING (IGNITION COVER)	1	▪	▪	▪	93210-357A3-00
X520004450182	O-RING (OIL FILTER)	1	▪	▪	▪	93210-45708-00
A820007012100	WASHER (CRANKCASE/IGNITION COVER)	2	▪	▪	▪	90430-06014-00
A820008014150	WASHER (CRANKCASE)	2	▪	▪	▪	90430-08119-00
X520002200180	O-RING (FRONT SPROCKET)	1	▪	▪	▪	93210-22164-00
X520001630240	O-RING (WATER HOSE SEAL)	1	▪	▪	▪	93210-16500-00
X520002350230	O-RING (WATER HOSE SEAL)	1	▪	▪	▪	93210-24253-00
X520001900250	O-RING (OIL FILLER CAP)	1	▪	▪	▪	93210-19123-00

RELATED PRODUCTS

ARTEIN PART No.	DESCRIPTION
KRV00HNOV0353	VALVE STEM SEALS KIT

XRADICAL
SUPER GASKETS

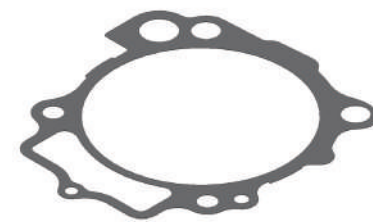

▲ P02D000005164 | 33D-11351-00 **K S J**
CYLINDER BASE GASKET



▲ P001000005165 | 33D-11181-00 **K S J**
CYLINDER HEAD GASKET



▲ P012000005169 | 33D-14613-00 **K S J**
EXHAUST GASKET

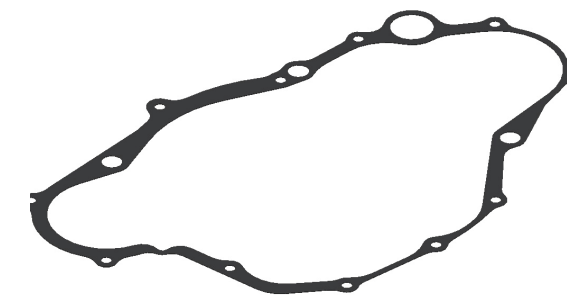

▲ P018000005168 | 33D-15462-00 **S J**
CLUTCH COVER GASKET

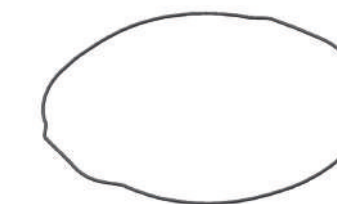

▲ P025000005167 | 33D-15453-00 **S J**
FRICTION DISC COVER GASKET (O-RING)

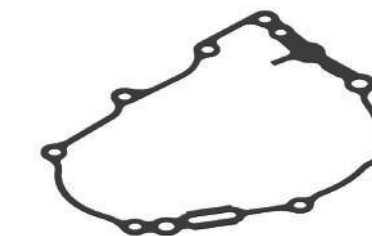

▲ P016000005166 | 33D-15451-00 **J**
IGNITION COVER GASKET



▲ P014000005150 | 33D-12427-00 **S J**
WATER PUMP COVER GASKET



▲ P010000005143 | 4FM-12213-00 **K S J**
DISTRIBUTION CHAIN TENSIONER GASKET

ARTEIN PART No.	DESCRIPTION	UNITS	TOP END KIT K0000YM0K0816	SMART KIT S0000YM0S0816	COMPLETE SET J0000YM000816	ORIGINAL PART No.
P001000005165	CYLINDER HEAD GASKET	1	▪	▪	▪	33D-11181-00
P02D000005170	CYLINDER BASE GASKET (0,25 MM)	1	▪	▪	▪	1SL-11351-00
P012000005169	EXHAUST GASKET	1	▪	▪	▪	33D-14613-00
P010000005143	DISTRIBUTION TENSIONER GASKET	1	▪	▪	▪	4FM-12213-00
A820007012100	WASHER (CYLINDER HEAD)	3	▪	▪	▪	90430-06014-00
A820008014150	WASHER (CYLINDER HEAD)	1	▪	▪	▪	90430-08119-00
A820006014100	WASHER (DISTRIBUTION TENSIONER)	1	▪	▪	▪	5EL-12214-00
KRVOOHNOV0353	VALVE STEM SEALS KIT	1	▪	▪	▪	-
P018000005172	CLUTCH COVER GASKET	1	▪	▪	▪	1SL-15462-00
P025000005167	FRICTION DISC COVER GASKET (O-RING)	1	▪	▪	▪	33D-15453-00
A820007012100	WASHER (WATER PUMP)	1	▪	▪	▪	90430-06014-00
X520001900182	O-RING (WATER HOSE SEAL)	1	▪	▪	▪	93210-19758-00
P014000005150	WATER PUMP COVER GASKET	1	▪	▪	▪	33D-12427-00
P016000005171	IGNITION COVER GASKET	1	▪	▪	▪	1SL-15451-00
A820007012100	WASHER (IGNITION COVER)	1	▪	▪	▪	90430-06014-00
X520001366230	O-RING (IGNITION COVER)	1	▪	▪	▪	93210-14369-00
X520003459262	O-RING (IGNITION COVER)	1	▪	▪	▪	93210-357A3-00
X520001250180	O-RING (OIL FILTER)	1	▪	▪	▪	93210-12010-00
X520004450182	O-RING (OIL FILTER)	1	▪	▪	▪	93210-45708-00
X520002200180	O-RING (FRONT SPROCKET)	1	▪	▪	▪	93210-22164-00
X520001630240	O-RING (WATER HOSE SEAL)	1	▪	▪	▪	93210-16500-00
X520002350230	O-RING (WATER HOSE SEAL)	1	▪	▪	▪	93210-24253-00
A820006014100	WASHER (CRANKCASE)	1	▪	▪	▪	90430-06166-00
A820011017150	WASHER (OIL PIPE)	1	▪	▪	▪	90430-10188-00
X520005800190	O-RING (ELECTRIC START)	1	▪	▪	▪	93210-58346-00
P025000005607	CRANKCASE PLATE GASKET	1	▪	▪	▪	1SL-13475-00
X520001900250	O-RING (OIL FILLER CAP)	1	▪	▪	▪	93210-19123-00

RELATED PRODUCTS	
ARTEIN PART No.	DESCRIPTION
KRVOOHNOV0353	VALVE STEM SEALS KIT

XRADICAL
SUPER GASKETS

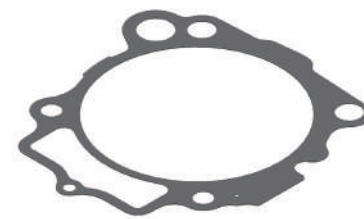

▲ P02D000005170 | 1SL-11351-00 **K S J**
CYLINDER BASE GASKET



▲ P001000005165 | 33D-11181-00 **K S J**
CYLINDER HEAD GASKET



▲ P012000005169 | 33D-14613-00 **K S J**
EXHAUST GASKET

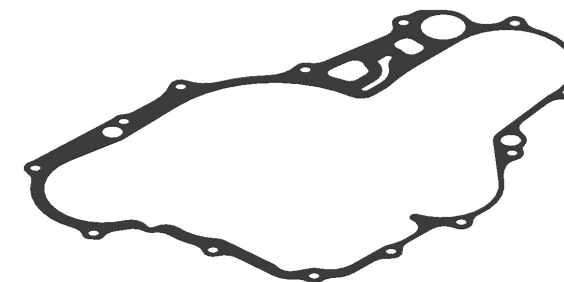

▲ P018000005172 | 1SL-15462-00 **S J**
CLUTCH COVER GASKET

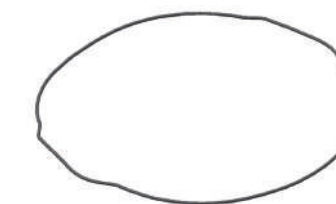

▲ P025000005167 | 33D-15453-00 **S J**
FRICTION DISC COVER GASKET (O-RING)



▲ P016000005171 | 1SL-15451-00 **J**
IGNITION COVER GASKET



▲ P014000005150 | 33D-12427-00 **S J**
WATER PUMP COVER GASKET



▲ P010000005143 | 4FM-12213-00 **K S J**
DISTRIBUTION CHAIN TENSIONER GASKET



▲ P025000005607 | 1SL-13475-00 **J**
CRANKCASE PLATE GASKET

XRADICAL
SUPER GASKETS



QUADS



ARTIC CAT
GAS GAS
HONDA
KAWASAKI
KTM
SUZUKI
YAMAHA

ARTEIN
gaskets

ARTEIN
gaskets

ARTEINGASKETS.COM

XRADICALSUPERGASKETS.COM

GASKETS · JOINTS · JUNTAS · GUARNIZIONI · DICHTUNGEN

ARTEIN PART No.	DESCRIPTION	UNITS	TOP END KIT K0000GGOK0860	SMART KIT S0000GGOS0860	COMPLETE SET J0000GG000860	ORIGINAL PART No.
X520010132178	O-RING (CYLINDER HEAD GASKET, OUTER) (200 CC)	1	▪	▪	▪	M01619135
X560007270178	O-RING (CYLINDER HEAD GASKET, INNER) (200-250 CC)	1	▪	▪	▪	ME25916065
X520010767178	O-RING (CYLINDER HEAD GASKET, OUTER) (250-300 CC)	1	▪	▪	▪	ME25916060
X560007592178	O-RING (CYLINDER HEAD GASKET, INNER) (300 CC)	1	▪	▪	▪	ME30916065
P02B000005464	CYLINDER BASE GASKET (0,15 MM)	1	▪	▪	▪	ME25644010
P02E000005464	CYLINDER BASE GASKET (0,3 MM)	1	▪	▪	▪	ME25644009
P02G000005464	CYLINDER BASE GASKET (0,5 MM)	1	▪	▪	▪	ME25644000
P012000005468	EXHAUST GASKET	1	▪	▪	▪	ME25644012
P025000005465	EXHAUST VALVE COVER GASKET, LEFT SIDE	1	▪	▪	▪	ME25644006
P025000005466	EXHAUST VALVE COVER GASKET, RIGHT SIDE	2	▪	▪	▪	ME25644007
X560004400300	O-RING (EXHAUST PIPE)	2	▪	▪	▪	BE250526006
A820008016150	WASHER (CYLINDER HEAD)	6	▪	▪	▪	T4008516
P025000005484	THERMOSTAT COVER GASKET (1998-2001)	1	▪	▪	▪	ME25944011
P025000005467	THERMOSTAT COVER GASKET (2002-2004)	1	▪	▪	▪	ME250344011
P015000005469	REED VALVE GASKET	1	▪	▪	▪	ME25644005
P018000005474	CLUTCH COVER GASKET	1	▪	▪	▪	ME25644002
P025000005475	FRICTION DISC COVER GASKET	1	▪	▪	▪	ME25644003
X520001200200	O-RING (OIL DRAIN)	1	▪	▪	▪	ME25610026
A820012018150	WASHER (OIL DRAIN)	1	▪	▪	▪	ME25810030
P014000005485	WATER PUMP COVER GASKET (1998)	1	▪	▪	▪	ME25644008
P014000005472	WATER PUMP COVER GASKET (1999-2004)	1	▪	▪	▪	ME25944008
A770006010150	WASHER (WATER PUMP)	1	▪	▪	▪	T4006010
P003000005486	CRANKCASE GASKET	1	▪	▪	▪	ME25944001
P016000005487	IGNITION COVER GASKET	1	▪	▪	▪	ME25644004
X520003200200	O-RING (CLUTCH SLAVE)	1	▪	▪	▪	ME25632024
X520002500200	O-RING (FRONT SPROCKET)	2	▪	▪	▪	ME25632025

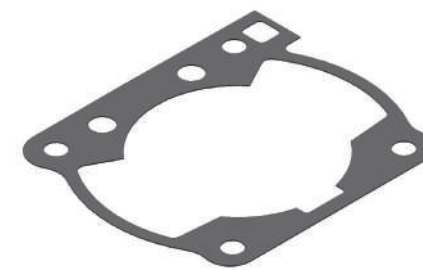

P02B000005464 | ME25644010 (0,15 mm)
P02E000005464 | ME25644009 (0,3 mm)
P02G000005464 | ME25644000 (0,5 mm) **K S J**

CYLINDER BASE GASKET



P012000005468 | ME25644012 **K S J**

EXHAUST GASKET



P003000005486 | ME25944001 **J**

CRANKCASE GASKET

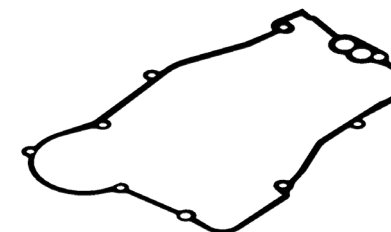

P018000005474 | ME25644002 **S J**

CLUTCH COVER GASKET

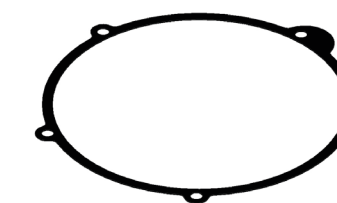

P025000005475 | ME25644003 **S J**

FRICTION DISC COVER GASKET



P016000005487 | ME25644004 **J**

IGNITION COVER GASKET



P014000005485 | ME25644008
P014000005472 | ME25944008 **S J**

WATER PUMP COVER GASKET



P025000005466 | ME25644007 **K S J**

EXHAUST VALVE COVER GASKET, RIGHT SIDE

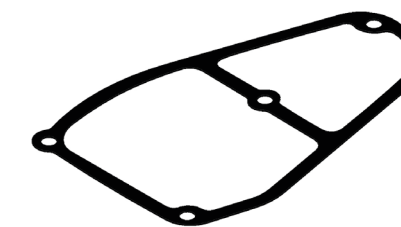
2 UNITS

P025000005465 | ME25644006 **K S J**

EXHAUST VALVE COVER GASKET, LEFT SIDE

ARTEIN PART No.	DESCRIPTION	UNITS	TOP END KIT K0000GGOK0861	SMART KIT S0000GGOS0861	COMPLETE SET J0000GG000861	ORIGINAL PART No.
X520010132178	O-RING (CYLINDER HEAD GASKET, OUTER) (200 CC)	1	▪	▪	▪	M01619135
X560007270178	O-RING (CYLINDER HEAD GASKET, INNER) (200-250 CC)	1	▪	▪	▪	ME25916065
X520010767178	O-RING (CYLINDER HEAD GASKE, OUTER) (250-300 CC)	1	▪	▪	▪	ME25916060
X560007592178	O-RING (CYLINDER HEAD GASKET, INNER) (300 CC)	1	▪	▪	▪	ME30916065
P02B000005464	CYLINDER BASE GASKET (0,15 MM)	1	▪	▪	▪	ME25644010
P02E000005464	CYLINDER BASE GASKET (0,3 MM)	1	▪	▪	▪	ME25644009
P02G000005464	CYLINDER BASE GASKET (0,5 MM)	1	▪	▪	▪	ME25644000
P012000005468	EXHAUST GASKET	1	▪	▪	▪	ME25644012
P025000005465	EXHAUST VALVE COVER GASKET, LEFT SIDE	1	▪	▪	▪	ME25644006
P025000005466	EXHAUST VALVE COVER GASKET, RIGHT SIDE	2	▪	▪	▪	ME25644007
X560004400300	O-RING (EXHAUST PIPE)	2	▪	▪	▪	BE250526006
A820008016150	WASHER (CYLINDER HEAD)	6	▪	▪	▪	T4008516
P025000005467	THERMOSTAT COVER GASKET	1	▪	▪	▪	ME250344011
A820006010150	WASHER (THERMOSTAT COVER)	2	▪	▪	▪	ME25916002
P015000005469	REED VALVE GASKET	1	▪	▪	▪	ME25644005
P015000005470	REED VALVE GASKET	1	▪	▪	▪	ME250644005
P015000005471	REED VALVE GASKET	1	▪	▪	▪	ME250644105
P018000005474	CLUTCH COVER GASKET	1	▪	▪	▪	ME25644002
P025000005475	FRICTION DISC COVER GASKET	1	▪	▪	▪	ME25644003
X520001200200	O-RING (OIL DRAIN)	1	▪	▪	▪	ME25610026
A820012018150	WASHER (OIL DRAIN)	1	▪	▪	▪	ME25810030
P014000005472	WATER PUMP COVER GASKET	1	▪	▪	▪	ME25944008
A770006010150	WASHER (WATER PUMP)	1	▪	▪	▪	T4006010
P003000005473	CRANKCASE GASKET	1	▪	▪	▪	ME9000013012
P016000005476	IGNITION COVER GASKET	1	▪	▪	▪	ME250544004
X520003200200	O-RING (CLUTCH SLAVE)	1	▪	▪	▪	ME25632024
X520002500200	O-RING (FRONT SPROCKET)	2	▪	▪	▪	ME25632025

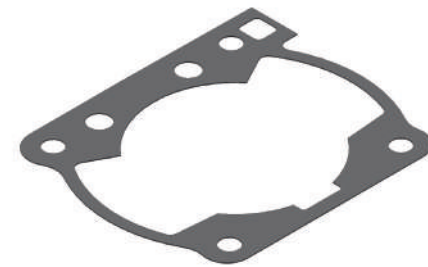

P02B000005464 | ME25644010 (0,15 mm)
P02E000005464 | ME25644009 (0,3 mm)
P02G000005464 | ME25644000 (0,5 mm) **K S J**

CYLINDER BASE GASKET



P012000005468 | ME25644012 **K S J**

EXHAUST GASKET



P003000005473 | ME9000013012 **J**

CRANKCASE GASKET

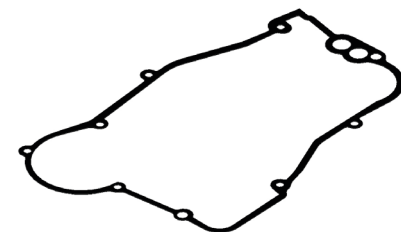

P018000005474 | ME25644002 **S J**

CLUTCH COVER GASKET

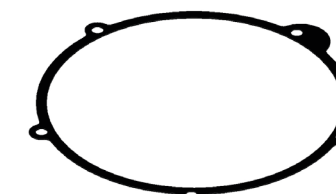

P025000005475 | ME25644003 **S J**

FRICTION DISC COVER GASKET



P016000005476 | ME250544004 **J**

IGNITION COVER GASKET



P014000005472 | ME25944008 **S J**

WATER PUMP COVER GASKET



P025000005466 | ME25644007 **K S J**

EXHAUST VALVE COVER GASKET, RIGHT SIDE

2 UNITS

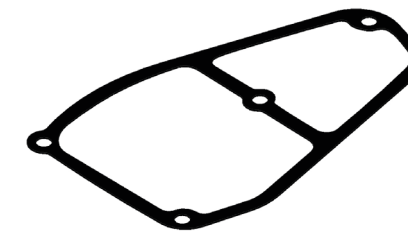

P025000005465 | ME25644006 **K S J**

EXHAUST VALVE COVER GASKET, LEFT SIDE

ARTEIN PART No.	DESCRIPTION	UNITS	TOP END KIT K0000HN0K0353	SMART KIT S0000HN0S0353	COMPLETE SET J0000HN000353	ORIGINAL PART No.
P001000004270	CYLINDER HEAD GASKET	1	▪	▪	▪	12251-HN1-A41
P001000004271	CYLINDER HEAD COVER GASKET	1	▪	▪	▪	12391-KCY-671
P02G000004273	CYLINDER BASE GASKET (0,5 MM)	1	▪	▪	▪	12191-KCY-672
X560008800200	O-RING (CYLINDER BASE)	1	▪	▪	▪	91302-356-000
P012000XR1267	EXHAUST GASKET	2	▪	▪	▪	18291-MN5-650
P010000005262	DISTRIBUTION TENSIONER GASKET	1	▪	▪	▪	14560-KCW-851
KRV00HNOV0353	VALVE STEM SEALS KIT	1	▪	▪	▪	-
X520000950160	O-RING (DISTRIBUTION TENSIONER)	1	▪	▪	▪	91306-MG-000
X520004500250	O-RING (INTAKE GASKET)	1	▪	▪	▪	91303-397-000
X520003500300	O-RING (HEAD COVER CAP)	4	▪	▪	▪	91301-428-003
P018000004276	CLUTCH COVER GASKET	1	▪	▪	▪	11394-HN1-A40
A820012018150	WASHER (OIL DRAIN)	3	▪	▪	▪	94109-12000
A820014020150	WASHER (ROCKER ARM)	4	▪	▪	▪	90544-KF0-000
X520000550150	O-RING (DOWEL PIN)	1	▪	▪	▪	91319-ME5-003
A820012018150	WASHER (OIL DRAIN)	4	▪	▪	▪	90545-KF0-000
P003000004275	CRANKCASE GASKET	1	▪	▪	▪	11191-HN1-A40
P016000004277	IGNITION COVER GASKET	1	▪	▪	▪	11395-KCY-672
P014000004278	ELECTRIC START COVER GASKET	1	▪	▪	▪	11377-HN1-010
X520005400250	O-RING (OIL FILTER)	1	▪	▪	▪	91302-KF0-003
X520002700200	O-RING (IGNITION COVER)	1	▪	▪	▪	91305-KF0-003
P013000005500	OIL PUMP GASKET	1	▪	▪	▪	15152-KCY-670
X520001800300	O-RING (OIL FILLER CAP)	1	▪	▪	▪	91302-KE8-003

RELATED PRODUCTS

ARTEIN PART No.	DESCRIPTION
KRV00HNOV0353	VALVE STEM SEALS KIT

XRADICAL
SUPER GASKETS



▲ P001000004270 | 12251-HN1-A41 **K S J**
CYLINDER HEAD GASKET

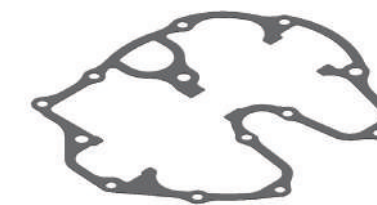

▲ P001000004271 | 12391-KCY-671 **K S J**
CYLINDER HEAD COVER GASKET



▲ P02G000004273 | 12191-KCY-672 **K S J**
CYLINDER BASE GASKET



▲ P010000005262 | 14560-KCW-851 **K S J**
DISTRIBUTION TENSIONER GASKET



▲ P018000004276 | 11394-HN1-A40 **S J**
CLUTCH COVER GASKET



▲ P003000004275 | 11191-HN1-A40 **J**
CRANKCASE GASKET



▲ P016000004277 | 11395-KCY-672 **J**
IGNITION COVER GASKET



▲ P014000004278 | 11377-HN1-010 **J**
ELECTRIC START COVER GASKET



▲ P013000005500 | 15152-KCY-670 **J**
OIL PUMP GASKET

ARTEIN PART No.	DESCRIPTION	UNITS	TOP END KIT K0000HN0K0354	SMART KIT S0000HN0S0354	COMPLETE SET J0000HN000354	ORIGINAL PART No.
P001000004280	CYLINDER HEAD GASKET	1	▪	▪	▪	12251-HP1-671
P02F000004279	CYLINDER BASE GASKET (0,4 MM)	1	▪	▪	▪	12191-HP1-671
P012000XR4282	EXHAUST GASKET	1	▪	▪	▪	18291-MEB-670
P010000004281	DISTRIBUTION TENSIONER GASKET	1	▪	▪	▪	14523-MAL-A01
KRV00HNOV0353	VALVE STEM SEALS KIT	1	▪	▪	▪	-
A801006014100	WASHER (DISTRIBUTION TENSIONER)	1	▪	▪	▪	90442-397-000
X520004500250	O-RING (THERMOSTAT COVER)	1	▪	▪	▪	91373-733-003
P018000004284	CLUTCH COVER GASKET	1	▪	▪	▪	11394-HP1-670
P025000004288	FRICTION DISC COVER GASKET (O-RING)	1	▪	▪	▪	11352-HP1-670
X520002700200	O-RING (OIL LEVEL)	1	▪	▪	▪	91305-KF0-003
A801008014150	WASHER (OIL DRAIN)	2	▪	▪	▪	90474-333-000
P014000004286	WATER PUMP COVER GASKET (O-RING)	1	▪	▪	▪	19226-HP1-670
X520001800240	O-RING (CLUTCH COVER)	1	▪	▪	▪	91256-383-721
A801006012150	WASHER (OIL DRAIN/WATER PUMP)	2	▪	▪	▪	90430-PD6-003
X520001400250	O-RING (OIL DRAIN)	1	▪	▪	▪	91303-MG7-003
P003000004283	CRANKCASE GASKET	1	▪	▪	▪	11191-HP1-670
P016000004285	IGNITION COVER GASKET	1	▪	▪	▪	11395-HP1-670
X520003980220	O-RING (OIL FILTER)	1	▪	▪	▪	91302-PA9-003
X520001000200	O-RING (BREATHER)	1	▪	▪	▪	91304-HA5-003
X520000800180	O-RING (OIL PUMP)	1	▪	▪	▪	90751-GK1-003
X520001800300	O-RING (OIL FILLER CAP)	2	▪	▪	▪	91307-035-000

RELATED PRODUCTS

ARTEIN PART No.	DESCRIPTION
KRV00HNOV0353	VALVE STEM SEALS KIT

XRADICAL
SUPER GASKETS



▲ P02F000004279 | 12191-HP1-671
CYLINDER BASE GASKET



▲ P001000004280 | 12251-HP1-671
CYLINDER HEAD GASKET



▲ P003000004283 | 11191-HP1-670
CRANKCASE GASKET



▲ P010000004281 | 14523-MAL-A01
DISTRIBUTION TENSIONER GASKET

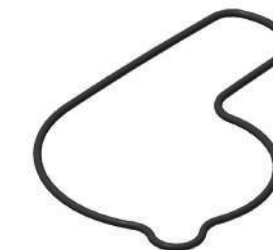

▲ P014000004286 | 19226-HP1-670
WATER PUMP COVER GASKET (O-RING)



▲ P016000004285 | 11395-HP1-670
IGNITION COVER GASKET



▲ P018000004284 | 11394-HP1-670
CLUTCH COVER GASKET

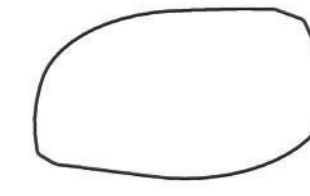

▲ P025000004288 | 11352-HP1-670
FRICTION DISC COVER GASKET (O-RING)

ARTEIN PART No.	DESCRIPTION	UNITS	TOP END KIT K0000KT0K0808	SMART KIT S0000KT0S0808	COMPLETE SET J0000KT000808	ORIGINAL PART No.
P001000005086	CYLINDER HEAD GASKET	1	•	•	•	77330036000
X560010770178	O-RING (CYLINDER BASE GASKET)	2	•	•	•	770108018
P012000005087	EXHAUST GASKET	1	•	•	•	77336041000
P025000005083	GEAR CASE COVER GASKET	1	•	•	•	77330035000
KRV00KT0V0808	VALVE STEM SEALS KIT	1	•	•	•	-
X520001000100	O-RING (DISTRIBUTION TENSIONER)	1	•	•	•	770010010
A820024030150	WASHER (DISTRIBUTION TENSIONER)	1	•	•	•	603242920
X520001800200	O-RING (DISTRIBUTION TENSIONER)	1	•	•	•	770180020
X520002500150	O-RING (CAMSHAFT HOLDER)	1	•	•	•	770250015
X520000600150	O-RING (CAMSHAFT HOLDER)	2	•	•	•	770060015
X520001500178	O-RING (CYLINDER HEAD)	2	•	•	•	770015018
X520001200150	O-RING (CYLINDER HEAD)	2	•	•	•	770012015
X520000900150	O-RING (CYLINDER HEAD)	2	•	•	•	770090015
P025000005082	FRICITION DISC COVER GASKET	1	•	•	•	77330027000
A820012018150	WASHER (OIL DRAIN)	1	•	•	•	58038022000
X520000800150	O-RING (CLUTCH COVER)	1	•	•	•	770080015
A820008012100	WASHER (OIL DRAIN)	1	•	•	•	603082121
A820006010100	WASHER (WATER PUMP)	1	•	•	•	603061001
P014000005084	WATER PUMP COVER GASKET	1	•	•	•	77335053000
X560Q02830178	Q-RING (WATER PUMP)	1	•	•	•	77335005000
P013000005088	OIL PUMP GASKET	1	•	•	•	77338012000
P013000005089	OIL PUMP GASKET	1	•	•	•	77338112000
P016000005090	IGNITION COVER GASKET	1	•	•	•	77330040100
X520003800200	O-RING (CLUTCH SLAVE)	1	•	•	•	770380020
X520002200200	O-RING (IGNITION COVER)	1	•	•	•	770220020
X520003934262	O-RING (OIL FILTER)	2	•	•	•	770390261
X520002300150	O-RING (OIL FILTER)	2	•	•	•	770023015
X560003000200	O-RING (OIL FILTER)	1	•	•	•	770300020
X560003400150	O-RING (OIL FILTER)	1	•	•	•	770034015
X520003305178	O-RING (OIL FILTER)	1	•	•	•	7703305178
X520002500150	O-RING (FRONT SPROCKET)	1	•	•	•	770250015
A820014020150	WASHER (OIL PUMP)	1	•	•	•	603142016
X520001900300	O-RING (OIL FILLER CAP)	1	•	•	•	770191015

RELATED PRODUCTS

ARTEIN PART No.	DESCRIPTION
KRV00KT0V0808	VALVE STEM SEALS KIT



▲ P001000005086 | 77330036000 **K S J**
CYLINDER HEAD GASKET



▲ P025000005083 | 77330035000 **K S J**
GEAR CASE COVER GASKET



▲ P012000005087 | 77336041000 **K S J**
EXHAUST GASKET



▲ P016000005090 | 77330040100 **J**
IGNITION COVER GASKET

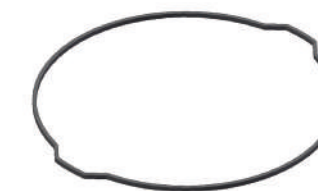

▲ P025000005082 | 77330027000 **S J**
FRICITION DISC COVER GASKET



▲ P014000005084 | 77335053000 **S J**
WATER PUMP COVER GASKET



▲ P013000005088 | 77338012000 **J**
OIL PUMP PRESSURE GASKET



▲ P013000005089 | 77338112000 **J**
OIL PUMP PRESSURE GASKET

ARTEIN PART No.	DESCRIPTION	UNITS	TOP END KIT K0000SZ0K0471	SMART KIT S0000SZ0S0471	COMPLETE SET J0000SZ000471	ORIGINAL PART No.
P001000004253	CYLINDER HEAD GASKET	1	▪	▪	▪	11141-29F01-000
P02H000004255	CYLINDER BASE GASKET (0,6 MM)	1	▪	▪	▪	11241-29F11-000
P012000XR4256	EXHAUST GASKET	1	▪	▪	▪	14181-29E02-000
P010000004259	DISTRIBUTION TENSIONER GASKET	1	▪	▪	▪	12837-24A10-000
A801009014200	WASHER (DISTRIBUTION TENSIONER)	1	▪	▪	▪	12837-24F10-000
KRV00SZ0V0471	VALVE STEM SEALS KIT	1	▪	▪	▪	-
P018000005313	CLUTCH COVER GASKET	1	▪	▪	▪	11482-07G10-000
A820012016200	WASHER (OIL DRAIN)	1	▪	▪	▪	09168-12002-000
X520002200250	O-RING (WATER PUMP)	1	▪	▪	▪	09280-22001-000
X520003100200	O-RING (WATER PUMP)	1	▪	▪	▪	17435-33400-000
X520008200200	O-RING (WATER PUMP)	1	▪	▪	▪	17418-07G00-000
A801006511150	WASHER (WATER PUMP)	1	▪	▪	▪	17413-28C10-000
P016000004814	IGNITION COVER GASKET	1	▪	▪	▪	11483-07G10-000
X520003270300	O-RING (IGNITION COVER)	1	▪	▪	▪	09280-33004-000
X560006952262	O-RING (ELECTRIC START)	1	▪	▪	▪	09280-71004-000
X520000480180	O-RING (OIL PIPE)	3	▪	▪	▪	09280-05004-000
X520000681190	O-RING (OIL PIPE)	1	▪	▪	▪	09280-07004-000
X520001300200	O-RING (OIL PUMP)	1	▪	▪	▪	09280-13004-000
X520005260240	O-RING (OIL PUMP)	1	▪	▪	▪	09280-54001-000
X520001100250	O-RING (OIL PIPE)	3	▪	▪	▪	09280-11005-000
X520001700300	O-RING (OIL FILLER CAP)	1	▪	▪	▪	09280-17003-000
A820008016150	WASHER (OIL TANK)	1	▪	▪	▪	09168-08016-000
A820014018150	WASHER (OIL PIPE)	2	▪	▪	▪	09168-M14-015-000

RELATED PRODUCTS

ARTEIN PART No.	DESCRIPTION
KRV00SZ0V0471	VALVE STEM SEALS KIT

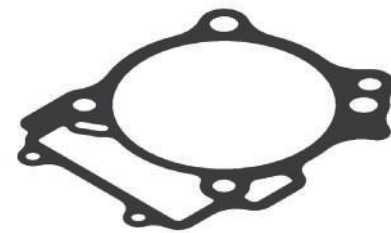
XRADICAL
 SUPER GASKETS

 ▲ P02H000004255 | 11241-29F11-000 **K S J**
 CYLINDER BASE GASKET

 ▲ P001000004253 | 11141-29F01-000 **K S J**
 CYLINDER HEAD GASKET

 ▲ P010000004259 | 12837-24A10-000 **K S J**
 DISTRIBUTION TENSIONER GASKET

 ▲ P016000004814 | 11483-07G10-000 **J**
 IGNITION COVER GASKET

 ▲ P018000005313 | 11482-07G10-000 **S J**
 CLUTCH COVER GASKET

 ▲ P012000XR4256 | 14181-29E02-000 **K S J**
 EXHAUST GASKET

ARTEIN PART No.	DESCRIPTION	UNITS	TOP END KIT K0000YM0K0378	SMART KIT S0000YM0S0378	COMPLETE SET J0000YM000378	ORIGINAL PART No.
P001000004230	CYLINDER HEAD GASKET	1	▪	▪	▪	2XJ-11181-00
P02F000004231	CYLINDER BASE GASKET (0,4 MM)	1	▪	▪	▪	-
P02G000004231	CYLINDER BASE GASKET (0,5 MM)	1	▪	▪	▪	3JM-11351-01
P02H000004231	CYLINDER BASE GASKET (0,6 MM)	1	▪	▪	▪	-
PO12000XR5163	EXHAUST GASKET	1	▪	▪	▪	3PA-14613-10
PO29000004232	REED VALVE GASKET	1	▪	▪	▪	3JM-13621-00
A820008014150	WASHER (CYLINDER HEAD)	6	▪	▪	▪	90201-08649-00
A820014020150	WASHER (OIL DRAIN)	1	▪	▪	▪	90201-12172-00
PO18000004229	CLUTCH COVER GASKET	1	▪	▪	▪	3JM-15451-11
PO13000004233	OIL PUMP GASKET	1	▪	▪	▪	126-13116-01
X520001900250	O-RING (OIL FILLER CAP)	1	▪	▪	▪	93210-19123-00



▲ P001000004230 | 2XJ-11181-00 **K S J**
CYLINDER HEAD GASKET



▲ P02F000004231 (0,4 mm)
P02G000004231 (0,5 mm)
P02H000004231 (0,6 mm) | 3JM-11351-01 **K S J**
CYLINDER BASE GASKET



▲ PO12000XR5163 | 3PA-14613-10 **K S J**
EXHAUST GASKET



▲ PO29000004232 | 3JM-13621-00 **K S J**
REED VALVE GASKET



▲ PO18000004229 | 3JM-15451-11 **S J**
CLUTCH COVER GASKET



▲ PO13000004233 | 126-13116-01 **J**
OIL PUMP GASKET

ARTEIN PART No.	DESCRIPTION	UNITS	TOP END KIT K0000YM0K0369	SMART KIT S0000YM0S0369	COMPLETE SET J0000YM000369	ORIGINAL PART No.
P001000004241	CYLINDER HEAD GASKET	1	▪	▪	▪	2GU-11181-00
P02G000004237	CYLINDER BASE GASKET (0,5 MM)	2	▪	▪	▪	3GG-11351-01
X560004500350	O-RING (EXHAUST GASKET)	2	▪	▪	▪	93210-45742-00
P029000004238	REED VALVE GASKET	2	▪	▪	▪	3GG-13621-00
P025000004240	THERMOSTAT COVER GASKET	1	▪	▪	▪	3XV-12435-00
A820014018150	WASHER (OIL DRAIN)	1	▪	▪	▪	90430-14043
P018000004236	CLUTCH COVER GASKET	1	▪	▪	▪	3GG-15461-02
P014000004239	WATER PUMP COVER GASKET	1	▪	▪	▪	3GG-12428-01
X520001700200	O-RING (WATER HOSE SEAL)	1	▪	▪	▪	93210-17239-00
A820006014100	WASHER (CRANKCASE)	1	▪	▪	▪	90430-06166-00
X520001900250	O-RING (OIL FILLER CAP)	1	▪	▪	▪	93210-19123-00

XRADICAL
SUPER GASKETS

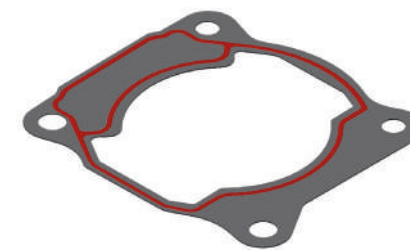

▲ P02G000004237 | 3GG-11351-01 **K S J**
CYLINDER BASE GASKET **2 UNITS**



▲ P001000004241 | 2GU-11181-00 **K S J**
CYLINDER HEAD GASKET



▲ P014000004239 | 3GG-12428-01 **S J**
WATER PUMP COVER GASKET



▲ P018000004236 | 3GG-15461-02 **S J**
CLUTCH COVER GASKET



▲ P025000004240 | 3XV-12435-00 **K S J**
THERMOSTAT COVER GASKET



▲ P029000004238 | 3GG-13621-00 **K S J**
REED VALVE GASKET **2 UNITS**

ARTEIN PART No.	DESCRIPTION	UNITS	TOP END KIT K0000YM0K0377	SMART KIT S0000YM0S0377	COMPLETE SET J0000YM000377	ORIGINAL PART No.
P001000004202	CYLINDER HEAD GASKET	1	▪	▪	▪	5TA-11181-00
P02G000004204	CYLINDER BASE GASKET (0,5 MM)	1	▪	▪	▪	5TA-11351-00
P012000XR4234	EXHAUST GASKET	1	▪	▪	▪	3VD-14613-01
P010000004203	DISTRIBUTION TENSIONER GASKET	1	▪	▪	▪	4FM-12213-00
A820007012100	WASHER (CYLINDER HEAD)	1	▪	▪	▪	90430-06014-00
KRV00YMOV0377	VALVE STEM SEALS KIT	1	▪	▪	▪	-
X520001900182	O-RING (WATER HOSE SEAL)	2	▪	▪	▪	93210-19758-00
P003000004200	CLUTCH COVER GASKET	1	▪	▪	▪	5TA-15462-00
P016000004201	FRICTION DISC COVER GASKET	1	▪	▪	▪	5TA-15453-00
A820010014150	WASHER (OIL PIPE)	1	▪	▪	▪	90430-10148-00
P014000005158	WATER PUMP COVER GASKET	1	▪	▪	▪	5BE-12439-00
P018000004205	IGNITION COVER GASKET	1	▪	▪	▪	5TG-15451-00
A820007012100	WASHER (WATER PUMP)	2	▪	▪	▪	90430-06014-00
X520001630240	O-RING (WATER HOSE SEAL)	2	▪	▪	▪	93210-16500-00
X520001000180	O-RING (OIL PUMP)	4	▪	▪	▪	93210-10197-00
X520000650178	O-RING (OIL PIPE)	1	▪	▪	▪	93210-07003-00
X520000900150	O-RING (OIL PIPE)	1	▪	▪	▪	93210-09008-00
X520001242178	O-RING (OIL PIPE)	1	▪	▪	▪	93210-12759-00
X520004700250	O-RING (OIL FILTER)	1	▪	▪	▪	93210-47675-00
X560000700250	O-RING (OIL FILTER)	3	▪	▪	▪	93210-07135-00
A820011017150	WASHER (OIL PIPE)	2	▪	▪	▪	90430-10188-00
A820008014150	WASHER (OIL PIPE)	4	▪	▪	▪	90430-08119-00
X520006000300	O-RING (ELECTRIC START)	1	▪	▪	▪	93210-60426-00
X520002700250	O-RING (IGNITION COVER)	1	▪	▪	▪	93210-27370-00
X520001366230	O-RING (IGNITION COVER)	1	▪	▪	▪	93210-14369-00
X520002200180	O-RING (FRONT SPROCKET)	1	▪	▪	▪	93210-22164-00
X520001900250	O-RING (OIL FILLER CAP)	1	▪	▪	▪	93210-19123-00

RELATED PRODUCTS	
ARTEIN PART No.	DESCRIPTION
KRV00YMOV0377	VALVE STEM SEALS KIT



▲ P02G000004204 | 5TA-11351-00 **K S J**
CYLINDER BASE GASKET



▲ P001000004202 | 5TA-11181-00 **K S J**
CYLINDER HEAD GASKET



▲ P003000004200 | 5TA-15462-00 **S J**
CLUTCH COVER GASKET



▲ P010000004203 | 4FM-12213-00 **K S J**
DISTRIBUTION TENSIONER GASKET

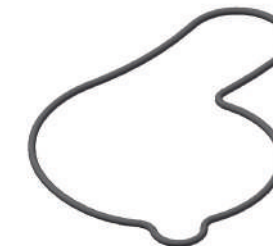

▲ P014000005158 | 5BE-12439-00 **S J**
WATER PUMP COVER GASKET



▲ P016000004201 | 5TA-15453-00 **S J**
FRICTION DISC COVER GASKET



▲ P018000004205 | 5TG-15451-00 **J**
IGNITION COVER GASKET



▲ P012000XR4234 | 3VD-14613-01 **K S J**
EXHAUST GASKET

ARTEIN PART No.	DESCRIPTION	UNITS	TOP END KIT K0000YM0K0379	SMART KIT S0000YM0S0379	COMPLETE SET J0000YM000379	ORIGINAL PART No.
P001000004248	CYLINDER HEAD GASKET	1	•	•	•	3YF-11181-00
P02D000004247	CYLINDER BASE GASKET (0,25 MM)	1	•	•	•	3YF-11351-00
X520007100300	O-RING (VALVE COVER)	1	•	•	•	93210-71360-00
X520003200220	O-RING (VALVE COVER)	2	•	•	•	93210-32172-00
X520001830240	O-RING (CAMSHAFT PLUG)	1	•	•	•	93210-19522-00
X520001330240	O-RING (ROCKER ARM PLUG)	1	•	•	•	93210-13657-00
X551010000300	O-RING (CYLINDER BASE)	1	•	•	•	93211-01467-00
KRV00YMOV0379	VALVE STEM SEALS KIT	1	•	•	•	-
P010000004242	DISTRIBUTION TENSIONER GASKET	1	•	•	•	4DW-12213-00
P012000XR4249	EXHAUST GASKET	2	•	•	•	3YF-14613-01
X520004350200	O-RING (INTAKE GASKET)	1	•	•	•	93210-44545-00
X520003050200	O-RING (INTAKE GASKET)	1	•	•	•	93210-30611-00
P018000004244	CLUTCH COVER GASKET	1	•	•	•	5LP-15462-00
A820007012100	WASHER (WATER PUMP)	1	•	•	•	90430-06014-00
X520008100250	O-RING (WATER PUMP, OUTER COVER)	1	•	•	•	1WG-12439-00
X551007750180	O-RING (WATER PUMP, INNER COVER)	1	•	•	•	93210-77363-00
A820014020150	WASHER (OIL DRAIN)	1	•	•	•	214-11198-01
P016000004245	IGNITION COVER GASKET	1	•	•	•	5LP-15451-00
P014000004246	ELECTRIC START COVER GASKET	1	•	•	•	5PL-15455-00
X520003300250	O-RING (WATER HOSE SEAL)	1	•	•	•	93210-33006-00
X520004900300	O-RING (THERMOSTAT COVER)	1	•	•	•	93210-49046-00
X520001786262	O-RING (WATER HOSE SEAL)	1	•	•	•	93210-18417-00
P013000004243	OIL PUMP GASKET	1	•	•	•	5LP-13329-00
X520001272250	O-RING (OIL PUMP/IGNITION COVER)	4	•	•	•	93210-13361-00
A820008014200	WASHER (OIL CIRCUIT)	4	•	•	•	90430-08204-00
A820011017150	WASHER (OIL CIRCUIT)	4	•	•	•	90430-10188-00
X520001366230	O-RING (IGNITION COVER)	1	•	•	•	93210-14369-00
X520003459262	O-RING (IGNITION COVER)	1	•	•	•	93210-357A3-00
A820008014150	WASHER (OIL DRAIN)	1	•	•	•	90201-11723-00
T520002025250	O-RING (OIL FILLER CAP)	1	•	•	•	93210-21190-00
X520002170200	O-RING (FRONT SPROCKET)	1	•	•	•	93210-22298-00

RELATED PRODUCTS	
ARTEIN PART No.	DESCRIPTION
KRV00YMOV0379	VALVE STEM SEALS KIT



▲ P001000004248 | 3YF-11181-00 **K S J**
CYLINDER HEAD GASKET

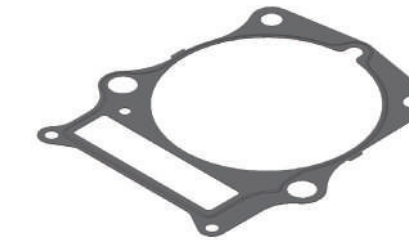

▲ P02D000004247 | 3YF-11351-00 **K S J**
CYLINDER BASE GASKET



▲ P010000004242 | 4DW-12213-00 **K S J**
DISTRIBUTION TENSIONER GASKET



▲ P018000004244 | 5LP-15462-00 **S J**
CLUTCH COVER GASKET



▲ P016000004245 | 5LP-15451-00 **J**
IGNITION COVER GASKET



▲ P014000004246 | 5PL-15455-00 **J**
ELECTRIC START COVER GASKET



▲ P013000004243 | 5LP-13329-00 **J**
OIL PUMP GASKET



▲ P012000XR4249 | 3YF-14613-01 **K S J**
EXHAUST GASKET **2 UNITS**

TEFIBRAL®

ADHESIVE THERMAL PROTECTOR

TEFIBRAL 490 HT (0,80 mm) • TEFIBRAL 1000 HT (1,60 mm)

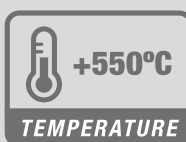

DESCRIPTION:

Thermal protector made of fibre glass tissue resistant to very high temperatures. It incorporates a thin refractile aluminium foil on one side and a technical adhesive with high performance adhesion on the other side.

High mechanical strength and adaptability to all surfaces.

HOW TO USE IT:

1. Draw the desired contour with a permanent marker and cut it with scissors.
2. Clean and dry deeply the surface to apply the Tefibral part.
3. Stick the Tefibral part into the surface to be protected.

WARNING: The adhesive must be placed on the surface to be protected, NEVER on the body originating heat (engine, exhaust...).

Part Number	Dimensions (mm)	Thickness (mm) / Density (g/m2)	Adhesive
VHPT000000080	140 x 195 (S)	0,80 / 490	HT (175°C)
VHPT000000160	140 x 195 (S)	1,60 / 1000	HT (175°C)
VHMT000000080	195 x 475 (M)	0,80 / 490	HT (175°C)
VHMT000000160	195 x 475 (M)	1,60 / 1000	HT (175°C)
VHGT000000080	300 x 450 (L)	0,80 / 490	HT (175°C)
VHGT000000160	300 x 450 (L)	1,60 / 1000	HT (175°C)

APPLICATION EXAMPLES IN A MOTORCYCLE

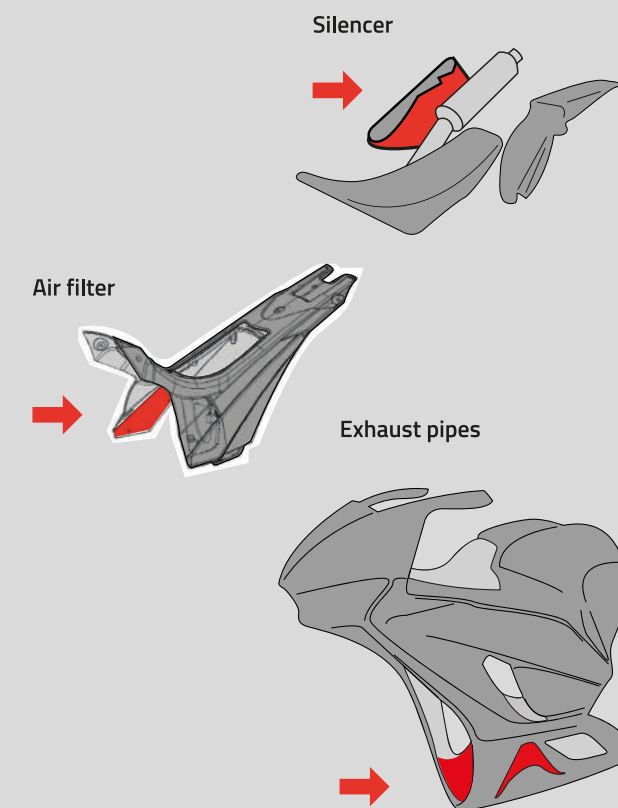

OTHER APPLICATIONS:
Protection of tank, battery, electronic devices...

WE TAKE CARE OF YOUR ENGINE



ALL MATERIALS HAVE BEEN ACCURATELY SELECTED TO PROVIDE THE BEST PERFORMANCE EVER SEEN.

Our new yellow top-grade material, ARTEIN CS6900 SOFT, provides an unprecedented combination of high compressibility, recovery and temperature resistance for engine areas with a low tightening torque.

FOAMET® gaskets (Aluminium core with two sides of Elastomer Foam coating) are also chosen for a low tightening sealing and a perfect adaptability.

For the cylinder heads, embossed multilayer steel (MLS) gaskets and single layer metal gaskets with elastomer coating are individually inspected to assure an optimal sealing under high mechanical and thermal stress.

To ensure any customised engine set up, for cylinder base gaskets, we use premium gasket material with low compressibility and controlled tolerance. Several thickness available for 2 Stroke engines.

XRADICAL

SUPER GASKETS



The information featured in this catalogue matches the technical specifications of all the components and contents of the gasket sets at the time of printing, save for error or omission. This information is non-binding.

ARTESANÍA INDUSTRIAL S.L. reserves the right to make changes in the part numbers, components and/or contents without notice, and without having to update this catalogue, always in order to keep improving.



www.xradicalsupergaskets.com
info@xradicalsupergaskets.com

XRADICAL
SUPER GASKETS



ARTEIN
gaskets



ARTEINGASKETS.COM

XRADICALSUPERGASKETS.COM